



PRADOLUX®



Pense na PRADOLUX quando precisar de soluções em sinalização e iluminação veicular.



Fabricação Nacional

Alta capacidade produtiva em duas plantas fabris para atender o mercado nacional e internacional.

Inovação em tecnologia LED

Desenvolvimento e fabricação de placas eletrônicas com alta tecnologia, trazendo ao mercado soluções inovadoras em sinalização veicular.

Desenvolvimento de Produtos

Experiência e inovação aliadas para desenvolver produtos e soluções através de tecnologias de ponta em desenho, simulação e manufatura de moldes e dispositivos.

Tecnologia de Produção

Investimento contínuo no aperfeiçoamento dos processos de produção e no desenvolvimento das pessoas em busca da excelência operacional com foco no cliente.

Soluções Específicas

Através de nossa equipe técnica especializada, nossos clientes contam com amplo suporte em suas necessidades de: treinamentos, aplicações, desenvolvimentos e marketing.

Variedade

Nossos clientes encontram na PRADOLUX a maior linha de produtos de sinalização para veículos pesados e comerciais do Brasil.

Qualidade Garantida

Empresa certificada segundo a norma de gestão de qualidade ISO 9001



Tel: 35 3729 - 6363

✉ vendas@pradolux.com.br

f /pradolux.official

www.pradolux.com.br

Av. João Pinheiro, 2200 - Pq. Industrial Ponte Preta - CEP 37701-386 - Poços de Caldas - MG

Empresa Certificada
ISO 9001



IMPLEMENTOS 05



UTILITÁRIOS 87



CAMINHÕES 33



ACESSÓRIOS 91



ÔNIBUS 82



SOQUETES 97

CÓDIGO DA SÉRIE	PÁG.	CÓDIGO DA SÉRIE	PÁG.	CÓDIGO DA SÉRIE	PÁG.	CÓDIGO DA SÉRIE	PÁG.	CÓDIGO DA SÉRIE	PÁG.	CÓDIGO DA SÉRIE	PÁG.		
PL0130	95	PL0494	36	PL0612	53	PL0786	57	PL1446	62	PL6020	75	PL9917	97
PL0140	95	PL0496	36	PL0614	64	PL0788	21	PL1452	06	PL6022	75	PL9918	97
PL0150	95	PL0498	53	PL0616	27	PL0790	19	PL1500	05	PL6024	42	PL9919	97
PL0152	95	PL0500	57	PL0638	26	PL0796	21	PL1527	45	PL6026	67	PL9920	97
PL0270	37	PL0502	91	PL0640	29	PL0798	21	PL1550	80	PL6028	61	PL9921	97
PL0306	40	PL0506	94	PL0642	29	PL0800	21	PL1614	64	PL6030	47	PL9922	97
PL0307	87	PL0508	94	PL0646	26	PL0802	91	PL1616	65	PL6032	47	PL9924	97
PL0312	24	PL0510	56	PL0650	96	PL0804	91	PL1618	73	PL6035	75	PL9926	98
PL0326	26	PL0512	95	PL0668	26	PL0806	20	PL1620	41	PL6036	47	PL9928	98
PL0348	51	PL0514	53	PL0678	25	PL0808	20	PL1622	71	PL6038	48	PL9929	98
PL0400	89	PL0516	57	PL0680	87	PL0818	20	PL1700	76	PL6040	67	PL9930	98
PL0402	87	PL0518	51	PL0684	25	PL0820	20	PL1702	80	PL6042	61	PL9931	98
PL0404	94	PL0520	54	PL0686	26	PL0826	40	PL1704	78	PL6050	67	PL9932	98
PL0406	36	PL0523	86	PL0688	25	PL0828	40	PL1708	77	PL7000	66	PL9934	98
PL0408	50	PL0524	24	PL0690	25	PL0830	41	PL1710	78	PL7002	48	PL9936	98
PL0410	50	PL0526	23	PL0692	41	PL0886	08	PL1800	5	PL7004	48	PL9946	98
PL0412	24	PL0528	54	PL0694	41	PL0890	69	PL2000	15	PL7006	34	PL9947	98
PL0414	94	PL0530	69	PL0696	71	PL0896	68	PL2004	15	PL7008	34	PL9948	98
PL0418	94	PL0532	55	PL0698	71	PL0898	70	PL2006	18	PL7010	33	PL9950	98
PL0420	40	PL0534	69	PL0700	76	PL0902	30	PL2008	15	PL7012	33	PL9951	98
PL0422	87	PL0536	23	PL0702	81	PL0904	31	PL2010	17	PL7014	33	PL9952	98
PL0424	88	PL0540	63	PL0704	77	PL0912	60	PL2038	16	PL7016	33	PL9953	98
PL0426	36	PL0542	91	PL0706	79	PL0916	60	PL2040	16	PL7018	66	PL9954	99
PL0428	57	PL0544	32	PL0708	75	PL0986	67	PL2048	16	PL7020	66	PL9955	99
PL0434	35	PL0547	71	PL0710	79	PL0994	19	PL2050	16	PL7022	66	PL9956	99
PL0436	89	PL0548	53	PL0714	76	PL0996	69	PL2054	17	PL7023	34	PL9958	99
PL0438	63	PL0552	94	PL0716	58	PL1000	90	PL2056	17	PL7026	49	PL9960	18
PL0440	38	PL0554	70	PL0719	18	PL1002	90	PL2058	14	PL7028	49	PL9964	19
PL0442	70	PL0558	23	PL0720	44	PL1004	90	PL2066	14	PL7031	48	PL9966	19
PL0444	63	PL0562	23	PL0722	42	PL1006	88	PL2070	14	PL9100	100	PL9968	19
PL0446	61	PL0564	27	PL0724	80	PL1008	88	PL2076	14	PL9101	100	PL9980	23
PL0448	52	PL0566	27	PL0728	81	PL1010	87	PL2090	17	PL9102	100	PL9983	99
PL0450	53	PL0570	18	PL0730	43	PL1012	89	PL2102	13	PL9103	100	PL9984	99
PL0452	93	PL0572	69	PL0731	19	PL1014	89	PL2104	13	PL9104	100	PL9985	99
PL0456	93	PL0574	54	PL0732	43	PL1016	88	PL2220	05	PL9105	100	PL9986	99
PL0458	93	PL0576	54	PL0734	42	PL1020	89	PL2300	10	PL9106	100	PL9987	99
PL0460	35	PL0578	25	PL0736	44	PL1022	89	PL2302	10	PL9107	100	PL9988	99
PL0462	37	PL0580	55	PL0738	42	PL1302	82	PL2304	11	PL9108	100	PL9990	99
PL0464	34	PL0582	22	PL0740	76	PL1308	83	PL2306	11	PL9109	100	PL9991	99
PL0466	50	PL0584	25	PL0742	43	PL1310	83	PL2400	09	PL9200	100	PL9994	99
PL0468	87	PL0586	23	PL0744	77	PL1312	82	PL2402	09	PL9201	100	PL9995	99
PL0470	37	PL0588	55	PL0746	78	PL1314	36	PL2600	12	PL9202	100	PL9996	99
PL0474	35	PL0590	86	PL0748	43	PL1316	84	PL2602	12	PL9203	100	PL9997	99
PL0476	51	PL0592	55	PL0750	64	PL1318	82	PL2604	12	PL9204	100	PL9998	99
PL0478	62	PL0594	56	PL0752	79	PL1322	32	PL2700	08	PL9205	100	PL9999	99
PL0480	32	PL0598	68	PL0754	43	PL1334	32	PL2702	07	PL9900	97		
PL0482	73	PL0600	92	PL0756	22	PL1338	82	PL6004	74	PL9901	97		
PL0484	63	PL0602	91	PL0758	22	PL1340	84	PL6006	47	PL9906	97		
PL0486	79	PL0604	91	PL0760	22	PL1354	22	PL6008	74	PL9911	97		
PL0488	88	PL0606	28	PL0762	22	PL1356	85	PL6010	74	PL9913	97		
PL0490	88	PL0608	28	PL0780	21	PL1427	51	PL6016	61	PL9914	97		
PL0492	55	PL0610	86	PL0782	21	PL1442	65	PL6018	74	PL9916	97		



O Projeto

O Grupo Pradolux acredita que para que haja um desenvolvimento sustentável precisamos AGIR com CONSCIÊNCIA para PRESERVAR o MEIO AMBIENTE.

Por isso, atualmente realizamos a coleta seletiva e o descarte correto, em lugares apropriados dos resíduos gerados no nosso processo produtivo.

E agora, nosso objetivo é propagar aos nossos clientes nossas práticas de descartes de resíduos.

Para participar

O Grupo Pradolux, irá disponibilizar um recipiente para armazenagem de resíduos que nossos produtos podem gerar (garantia, defeitos e quebras). Em meio as visitas aos clientes, os Representantes Comerciais, ficarão responsáveis de recolherem os resíduos armazenados pelo cliente e destiná-lo a uma cooperativa de reciclagem.

As cooperativas de reciclagem que vão receber esses resíduos serão beneficiadas, iremos ajudar indiretamente por meio do descarte dos resíduos, que serão entregues in loco e sem necessidade de pagamento por quilograma.

Além de beneficiar as cooperativas com a entrega desses resíduos, cada vez que um Representante de Vendas coletar o armazenamento e realizar o descarte correto, o Grupo Pradolux irá realizar uma doação em dinheiro para uma cooperativa de reciclagem de Poços de Caldas.

O que estamos fazendo

O Grupo realiza o descarte correto de todos os nossos resíduos e rejeitos através de empresas devidamente credenciadas nos órgãos ambientais, essa ação, vai de encontro com o projeto Pradolux mais Verde, porém agora com foco no público interno, para incentivar nossos colaboradores a realizarem a prática do descarte correto de resíduos dentro e fora da empresa.

*Convidamos sua empresa
para fazer parte da nossa iniciativa.*

*Faça parte de
um futuro mais verde.*



Com maior visibilidade,
iluminação indireta.
LED Bivolt.

Com funções de
posição, luz de ré, freio
e direcional sequencial

Com conector 5 vias e
3 conectores auxiliares 2 vias

Primeira e única lanterna modular do mercado!



PL 1500

Lanterna traseira Modulus ®
Com 57 LEDs bivolt.



CÓDIGO	DESCRIÇÃO	TENSÃO	LENTE	LADO	COR LENTE	EMB.
PL1500.01.67	Lanterna Modulus ®	LED BIVOLT	Acrílica	Direito	Bicolor	01
PL1500.02.67	Lanterna Modulus ®	LED BIVOLT	Acrílica	Esquerdo	Bicolor	01



PL 1800

Lanterna traseira Modulus ®
com triângulo e 75 LEDs bivolt



CÓDIGO	DESCRIÇÃO	TENSÃO	LENTE	LADO	COR LENTE	EMB.
PL1800.01.67	Lanterna Modulus ®	LED BIVOLT	Acrílica	Direito	Bicolor	01
PL1800.02.67	Lanterna Modulus ®	LED BIVOLT	Acrílica	Esquerdo	Bicolor	01

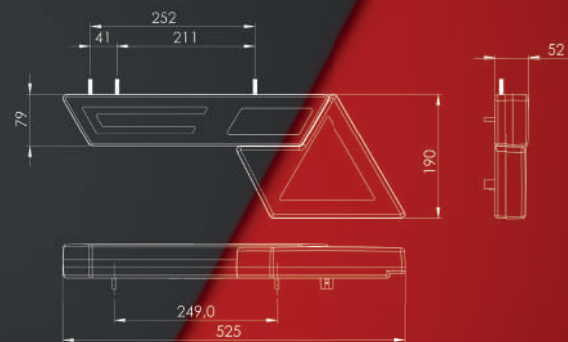

PL 2220

Lanterna traseira Modulus ®
com ponteira de acabamento e 75 LEDs bivolt



CÓDIGO	DESCRIÇÃO	TENSÃO	LENTE	LADO	COR LENTE	EMB.
PL2220.01.67	Lanterna Modulus ®	LED BIVOLT	Acrílica	Direito	Bicolor	01
PL2220.02.67	Lanterna Modulus ®	LED BIVOLT	Acrílica	Esquerdo	Bicolor	01

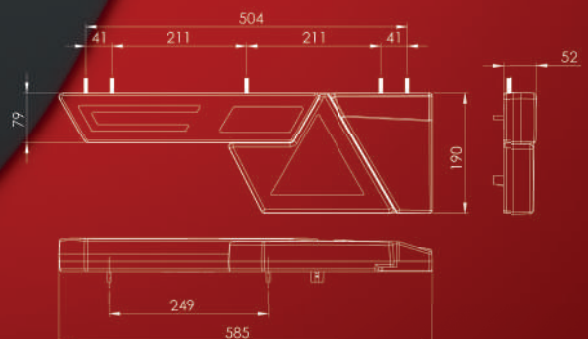

PL1802.01.63 - LD
PL1802.02.63 - LE

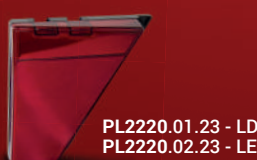

PL2220.01.23 - LD
PL2220.02.23 - LE

CÓDIGO	DESCRIÇÃO	TENSÃO	LENTE	LADO	COR LENTE	EMB.
PL1802.01.63	Triângulo retrorrefletor	LED BIVOLT	Acrílica	Direito	01	
PL1802.02.63	Triângulo retrorrefletor	LED BIVOLT	Acrílica	Esquerdo	01	
PL2220.01.23	Ponteira de acabamento	-	Acrílica	Direito	01	
PL2220.02.23	Ponteira de acabamento	-	Acrílica	Esquerdo	01	



PL9946.17.00



PL9953.39.00

REPOSIÇÃO	DESCRIÇÃO	EMB.
PL9946.17.00	Chicote com conector ultra seal 2 vias universal	10
PL9953.39.00	Chicote com conector ultra seal 5 vias e conector Faston 6,3mm	10

PL 1452

Lanterna traseira Triplo X PLUS LED
Com 66 LEDs e triângulo retrorrefletor
para implementos



Com 66 LEDs

Com conector 5 vias e
2 conectores auxiliares 2 vias

Com funções de
posição, luz de ré, freio
e direcional sequencial

Com triângulo retrorrefletor
para reboques e semirreboques

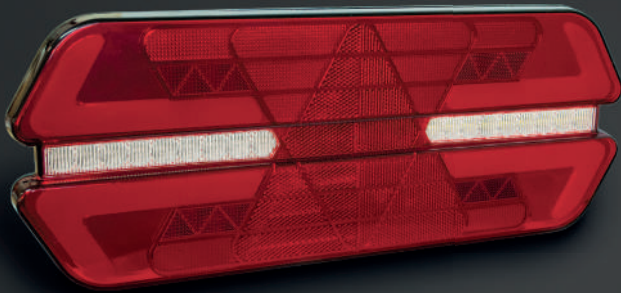

CÓDIGO	TENSÃO	LENTE	LADO	COR LENTE	EMB.
PL1452.01.47	LED BIVOLT	Acrílica	Direito	Bicolor	01
PL1452.02.47	LED BIVOLT	Acrílica	Esquerdo	Bicolor	01

CÓDIGO	DESCRIÇÃO	TENSÃO	LENTE	LADO	COR LENTE	EMB.
PL1452.57.47	Com haste ajustável	LED BIVOLT	Acrílica	Direito	Bicolor	01
PL1452.58.47	Com haste ajustável	LED BIVOLT	Acrílica	Esquerdo	Bicolor	01



PL9946.17.00



PL9953.39.00

REPOSIÇÃO	DESCRIÇÃO	EMB.
PL9946.17.00	Chicote com conector ultra seal 2 vias universal	10
PL9953.39.00	Chicote com conector ultra seal 5 vias e conector Faston 6,3mm	10

Fixação ajustável para todos os tipos de carretas

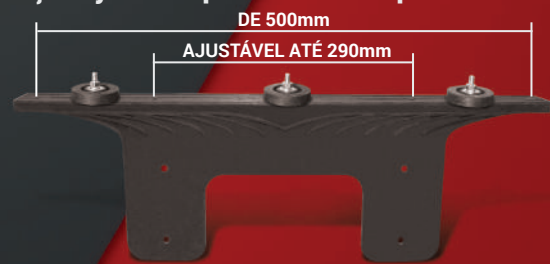

REPOSIÇÃO	DESCRIÇÃO	EMB.
PL1450.19.17	Haste ajustável para lanterna PL1452	04

Mais opções de conexões no caminhão



vista traseira

Lado esquerdo
Conexão 2 vias
para alarme sonoro
de ré (uso opcional)

Lado direito
Conexão 2 vias para luz de
Posição ou luz de Placa
(uso opcional)

Conexão 5 vias
para as funções
Posição, Seta, Ré
e Freio

Conexão 2 vias para
luz de Posição ou luz
de Placa (uso opcional)

vista frontal

394,8

vista lateral

80

vista superior

250

44,3

PL 2702
 Suporte traseiro Triplo X LED
 Com triângulo retrorrefletor
 para implementos

Lanterna lateral LED

Com conector 5 vias e
 2 conectores auxiliares 2 vias

Com funções de posição, luz de
 ré, freio e direcional sequencial

Com triângulo retrorrefletor
 para reboques e semirreboques



Com 76 LEDs



Com 50 LEDs



CÓDIGO	TENSÃO	LENTE	LADO	COR LENTE	EMB.	CÓDIGO	TENSÃO	LENTE	LADO	COR LENTE	EMB.
PL2702.01.67	LED BIVOLT	Acrílica	Direito	Bicolor	01	PL2702.11.67	LED 12V	Acrílica	Direito	Bicolor	01
PL2702.02.67	LED BIVOLT	Acrílica	Esquerdo	Bicolor	01	PL2702.12.67	LED 12V	Acrílica	Esquerdo	Bicolor	01
						PL2702.33.67	LED 24V	Acrílica	Direito	Bicolor	01
						PL2702.34.67	LED 24V	Acrílica	Esquerdo	Bicolor	01



PL2702.79.17 - LD
 PL2702.80.17 - LE



PL2702.00.00



PL2703.01.43 - LD
 PL2703.02.43 - LE

REPOSIÇÃO	DESCRIÇÃO	LADO	COR LENTE	EMB.
PL2702.79.17	Caixa para suporte Triplo X	Direito	Bicolor	01
PL2702.80.17	Caixa para suporte Triplo X	Esquerdo	Bicolor	01
PL2702.00.00	Lanterna lateral para caixa Triplo X		Amarela	01
PL2703.01.43	Guia de luz LED para caixa Triplo X	Direito	Vermelha	01
PL2703.02.43	Guia de luz LED para caixa Triplo X	Esquerdo	Vermelha	01

PL 1452
 Lanterna traseira Triplo X LED
 Com 40 LEDs e triângulo retrorrefletor
 para implementos

Com 40 LEDs

Com conector 5 vias e
 2 conectores auxiliares 2 vias

Com funções de posição,
 direcional, luz de ré e freio

Com triângulo retrorrefletor
 para reboques e semirreboques

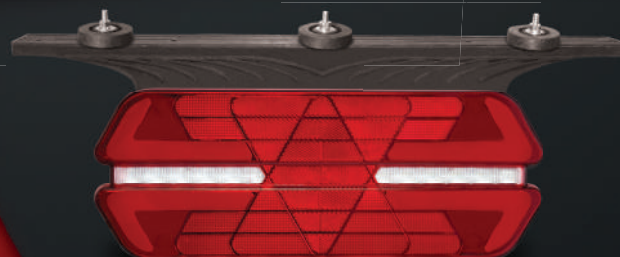
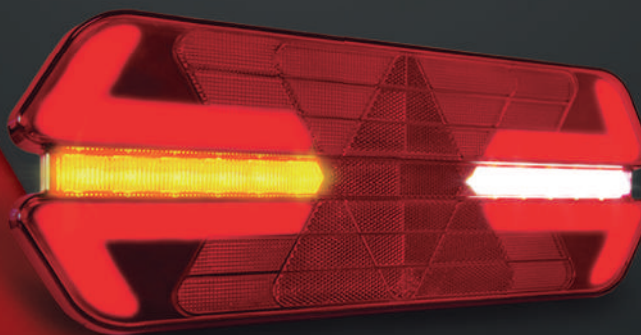

CÓDIGO	TENSÃO	LENTE	LADO	COR LENTE	EMB.	CÓDIGO	DESCRIÇÃO	TENSÃO	LENTE	LADO	COR LENTE	EMB.
PL1452.11.47	LED 12V	Acrílica	Direito	Bicolor	01	PL1452.79.47	Com haste ajustável	LED 12V	Acrílica	Direito	Bicolor	01
PL1452.12.47	LED 12V	Acrílica	Esquerdo	Bicolor	01	PL1452.80.47	Com haste ajustável	LED 12V	Acrílica	Esquerdo	Bicolor	01
PL1452.33.47	LED 24V	Acrílica	Direito	Bicolor	01	PL1452.61.47	Com haste ajustável	LED 24V	Acrílica	Direito	Bicolor	01
PL1452.34.47	LED 24V	Acrílica	Esquerdo	Bicolor	01	PL1452.62.47	Com haste ajustável	LED 24V	Acrílica	Esquerdo	Bicolor	01



PRIMO LUX



Phantom LED

PL 2700

Suporte traseiro Phantom LED para implementos

Com 42 LEDs

Com conector 5 vias e 2 conectores auxiliares 2 vias

Com funções de posição, direcional, luz de ré e freio

Com triângulo retrorrefletor para reboques e semirreboques

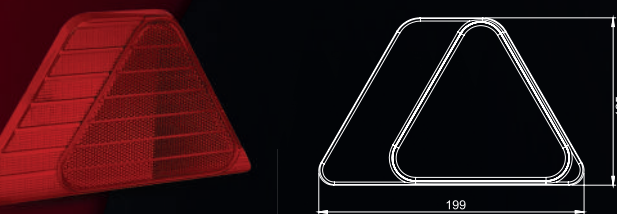
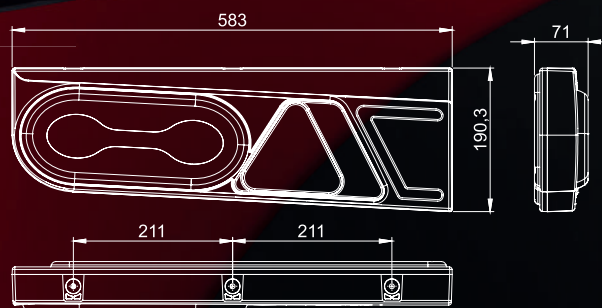
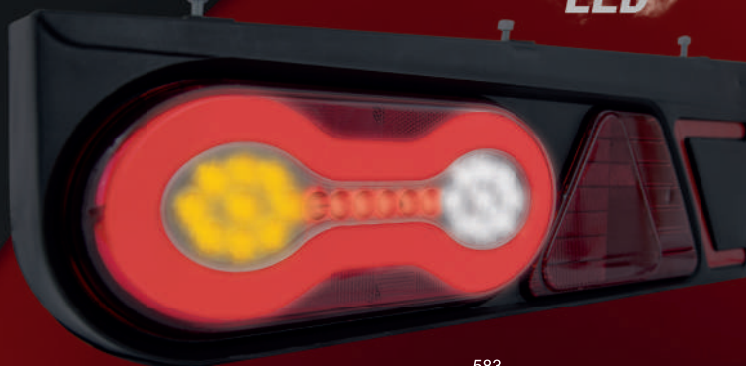

CÓDIGO	TENSÃO	LENTE	LADO	COR LENTE	EMB.
PL2700 .33.67	LED 24V	Acrílica	Direito	Bicolor	01
PL2700 .34.67	LED 24V	Acrílica	Esquerdo	Bicolor	01



CÓDIGO	DESCRIÇÃO	LADO	EMB.
PL2700 .65.17	Caixa com triângulo para suporte traseiro PL2700	Direito	01
PL2700 .66.17	Caixa com triângulo para suporte traseiro PL2700	Esquerdo	01

CÓDIGO	DESCRIÇÃO	LENTE	LADO	EMB.
PL0994 .01.23	Triângulo retrorrefletor para suporte PL2700	Acrílica	Direito	04
PL0994 .02.23	Triângulo retrorrefletor para suporte PL2700	Acrílica	Esquerdo	04

PL 0886

Lanterna traseira Phantom LED

Com 42 LEDs para implementos

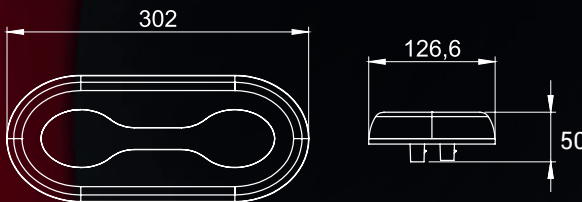

CÓDIGO	TENSÃO	LENTE	LADO	COR LENTE	EMB.
PL0886 .11.67	LED 12V	Acrílica	Direito	Bicolor	01
PL0886 .12.67	LED 12V	Acrílica	Esquerdo	Bicolor	01
PL0886 .33.67	LED 24V	Acrílica	Direito	Bicolor	01
PL0886 .34.67	LED 24V	Acrílica	Esquerdo	Bicolor	01

REPOSIÇÃO	DESCRIÇÃO	EMB.
PL0886 .00.00	Kit de parafusos para aplicação em caminhões	20

Lanterna completa com todas as funções



Acionamento completo

Posição Halo Light

Luz de ré

Direcional

Freio

Refletivo

PL9946 .17.00

REPOSIÇÃO	DESCRIÇÃO	EMB.
PL9946 .17.00	Chicote com conector ultra seal 2 vias universal	10
PL9953 .39.00	Chicote com conector ultra seal 5 vias e conector Faston 6,3mm	10

Mais opções de conexões no caminhão



vista traseira

Lado esquerdo
Conexão 2 vias para alarme sonoro de ré (uso opcional)

Lado direito
Conexão 2 vias para luz de Posição ou luz de Placa (uso opcional)

Conexão 5 vias para as funções Posição, Seta, Ré e Freio

Conexão 2 vias para luz de Posição ou luz de Placa (uso opcional)



PRADOUX



PL 2400
Suporte traseiro *Halo Light*
com triângulo
Aplicação universal



Função de posição
com a tecnologia *Halo Light*



Maior visibilidade e segurança

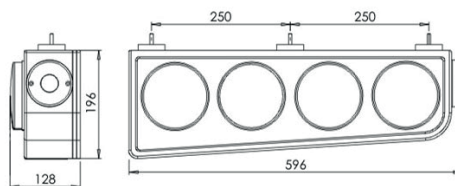

PL0806.24.65



PL0806.24.67



PL0806.24.63



PL0578.00.61



PL0731.00.23



PL2000.61.17 - LD
PL2000.62.17 - LE



PL9950.17.00



PL9951.37.00

CÓDIGO	DESCRIÇÃO	TENSÃO	LADO	EMB.	
PL2400.33.69	Suporte traseiro <i>Halo Light</i>	LED24V	Direito	01	
PL2400.34.69	Suporte traseiro <i>Halo Light</i>	LED24V	Esquerdo	01	
CÓDIGO	DESCRIÇÃO	TENSÃO	LENTE	COR	EMB.
PL0578.00.61	Lanterna lateral 66mm	LED BIVOLT	Acrílica	Amarelo	10
PL0731.00.23	Triângulo retrorrefletor	-	Acrílica	Vermelho	10
PL0806.24.65	Lanterna <i>Halo Light</i> 2 funções direcional e posição	LED24V	Acrílica	LED Amarelo e vermelho	01
PL0806.24.67	Lanterna <i>Halo Light</i> 2 funções luz de ré e posição	LED24V	Acrílica	LED Cristal e vermelho	01
PL0806.24.63	Lanterna <i>Halo Light</i> 2 funções freio e posição	LED24V	Acrílica	LED Vermelho	01
PL2000.61.17	Caixa para suporte traseiro - Lado direito				01
PL2000.62.17	Caixa para suporte traseiro - Lado esquerdo				01
PL9950.17.00	Chicote 2 vias para Faston 6,3mm				10
PL9951.37.00	Chicote 3 vias para Faston 6,3mm				10

PL 2402
Suporte traseiro *Halo Light*
Aplicação universal



Função de posição
com a tecnologia *Halo Light*



Maior visibilidade e segurança

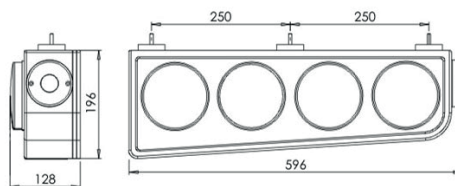

PL0806.24.65



PL0806.24.67



PL0806.24.63



PL0578.00.61



PL2000.61.17 - LD
PL2000.62.17 - LE



PL9950.17.00



PL9951.37.00

CÓDIGO	DESCRIÇÃO	TENSÃO	LADO	EMB.	
PL2402.33.69	Suporte traseiro <i>Halo Light</i>	LED24V	Direito	01	
PL2402.34.69	Suporte traseiro <i>Halo Light</i>	LED24V	Esquerdo	01	
CÓDIGO	DESCRIÇÃO	TENSÃO	LENTE	COR	EMB.
PL0578.00.61	Lanterna lateral 66mm	LED BIVOLT	Acrílica	Amarelo	10
PL0806.24.65	Lanterna <i>Halo Light</i> 2 funções direcional e posição	LED24V	Acrílica	LED Amarelo e vermelho	01
PL0806.24.67	Lanterna <i>Halo Light</i> 2 funções luz de ré e posição	LED24V	Acrílica	LED Cristal e vermelho	01
PL0806.24.63	Lanterna <i>Halo Light</i> 2 funções freio e posição	LED24V	Acrílica	LED Vermelho	01
PL2000.61.17	Caixa para suporte traseiro - Lado direito				01
PL2000.62.17	Caixa para suporte traseiro - Lado esquerdo				01
PL9950.17.00	Chicote 2 vias para Faston 6,3mm				10
PL9951.37.00	Chicote 3 vias para Faston 6,3mm				10



PL 2300

Suporte traseiro com LED
Aplicação universal

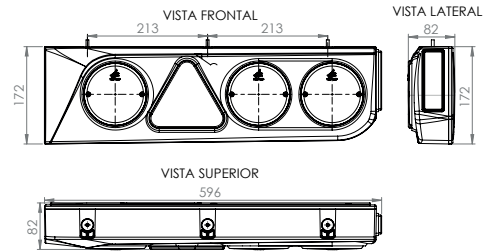

PL0796.24.61



PL0796.24.62



PL0796.24.63



PL0790.00.23



PL2300.61.17 - LD
PL2300.62.17 - LE



PL9950.17.00



PL9951.37.00

CÓDIGO	DESCRIÇÃO	TENSÃO	LADO	REF. ORIGINAL	EMB.
PL2300.33.69	Suporte traseiro	LED24V	Direito	9512576	01
PL2300.34.69	Suporte traseiro	LED24V	Esquerdo	9512577	01
CÓDIGO	DESCRIÇÃO	TENSÃO	LENTE	COR	EMB.
PL0796.24.61	Lanterna direcional	LED24V	Acrílica	Amarelo	05
PL0796.24.62	Lanterna luz de ré	LED24V	Acrílica	Cristal	05
PL0796.24.63	Lanterna freio e posição	LED24V	Acrílica	Vermelho	05
PL0790.00.23	Triângulo retrorrefletor	-	Acrílica	Vermelho	10
PL2300.61.17	Caixa com triângulo para suporte traseiro - Lado direito				01
PL2300.62.17	Caixa com triângulo para suporte traseiro - Lado esquerdo				01
PL9950.17.00	Chicote 2 vias para Faston 6,3mm				10
PL9951.37.00	Chicote 3 vias para Faston 6,3mm				10

PL 2302

Suporte traseiro com LED e aba
Aplicação universal

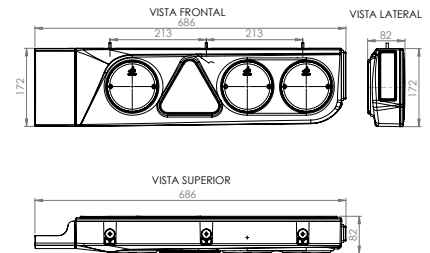

PL0796.24.61



PL0796.24.62



PL0796.24.63



PL0790.00.23



PL2302.61.17 - LD
PL2302.62.17 - LE



PL9950.17.00



PL9951.37.00

CÓDIGO	DESCRIÇÃO	TENSÃO	LADO	REF. ORIGINAL	EMB.
PL2302.33.69	Suporte traseiro com aba	LED24V	Direito	9512578	01
PL2302.34.69	Suporte traseiro com aba	LED24V	Esquerdo	9512579	01
CÓDIGO	DESCRIÇÃO	TENSÃO	LENTE	COR	EMB.
PL0796.24.61	Lanterna direcional	LED24V	Acrílica	Amarelo	05
PL0796.24.62	Lanterna luz de ré	LED24V	Acrílica	Cristal	05
PL0796.24.63	Lanterna freio e posição	LED24V	Acrílica	Vermelho	05
PL0790.00.23	Triângulo retrorrefletor	-	Acrílica	Vermelho	10
PL2302.61.17	Caixa com triângulo e aba para suporte traseiro - Lado direito				01
PL2302.62.17	Caixa com triângulo e aba para suporte traseiro - Lado esquerdo				01
PL9950.17.00	Chicote 2 vias para Faston 6,3mm				10
PL9951.37.00	Chicote 3 vias para Faston 6,3mm				10



PL 2304
Suporte traseiro com LED
Aplicação universal

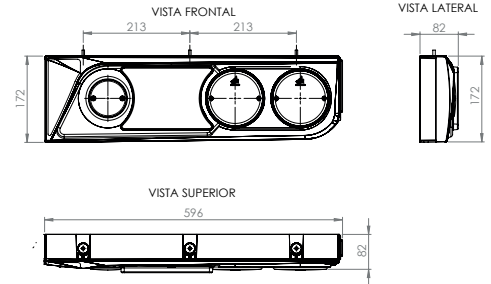

PL0798.24.61



PL0798.24.63



PL0800.00.62



PL0731.00.23



PL2304.61.17 - LD
PL2304.62.17 - LE



PL9950.17.00



PL9951.37.00



PL9946.17.00

CÓDIGO	DESCRIÇÃO	TENSÃO	LADO	REF. ORIGINAL	EMB.
PL2304.33.69	Suporte traseiro	LED24V	Direito	9517157	01
PL2304.34.69	Suporte traseiro	LED24V	Esquerdo	9517156	01
CÓDIGO	DESCRIÇÃO	TENSÃO	LENTE	COR	EMB.
PL0798.24.61	Lanterna direcional	LED24V	Acrílica	LED Amarelo	05
PL0798.24.63	Lanterna freio e posição	LED24V	Acrílica	LED Vermelho	05
PL0800.00.62	Lanterna luz de ré 75mm	LED24V	Acrílica	Cristal	10
PL0731.00.23	Triângulo retrorrefletor	-	Acrílica	Vermelho	10
PL2304.61.17	Caixa com triângulo para suporte traseiro - Lado direito				01
PL2304.62.17	Caixa com triângulo para suporte traseiro - Lado esquerdo				01
PL9946.17.00	Chicote com conector ultra seal 2 vias universal				10
PL9950.17.00	Chicote 2 vias para Faston 6,3mm				10
PL9951.37.00	Chicote 3 vias para Faston 6,3mm				10

PL 2306
Suporte traseiro com LED e aba
Aplicação universal

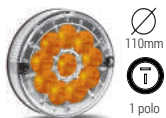
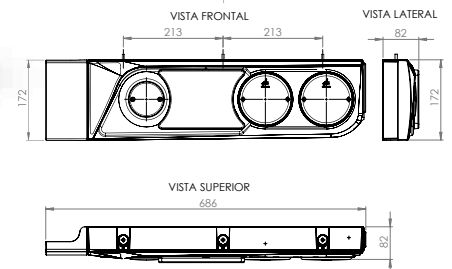

PL0798.24.61



PL0798.24.63



PL0800.00.62



PL0731.00.23



PL2306.61.17 - LD
PL2306.62.17 - LE



PL9950.17.00



PL9951.37.00



PL9946.17.00

CÓDIGO	DESCRIÇÃO	TENSÃO	LADO	REF. ORIGINAL	EMB.
PL2306.33.69	Suporte traseiro com aba	LED24V	Direito	9516653	01
PL2306.34.69	Suporte traseiro com aba	LED24V	Esquerdo	9516654	01
CÓDIGO	DESCRIÇÃO	TENSÃO	LENTE	COR	EMB.
PL0798.24.61	Lanterna direcional	LED24V	Acrílica	LED Amarelo	05
PL0798.24.63	Lanterna freio e posição	LED24V	Acrílica	LED Vermelho	05
PL0800.00.62	Lanterna luz de ré 75mm	LED24V	Acrílica	Cristal	10
PL0731.00.23	Triângulo retrorrefletor	-	Acrílica	Vermelho	10
PL2306.61.17	Caixa com triângulo para suporte traseiro - Lado direito				01
PL2306.62.17	Caixa com triângulo para suporte traseiro - Lado esquerdo				01
PL9946.17.00	Chicote com conector ultra seal 2 vias universal				10
PL9950.17.00	Chicote 2 vias para Faston 6,3mm				10
PL9951.37.00	Chicote 3 vias para Faston 6,3mm				10



PL 2600

Suporte traseiro LED Com triângulo retrorrefletor para implementos



PL0820.00.65

Lanterna acesa

PL0820.00.67

Lanterna acesa

PL0731.00.23

PL9984.42.13 Lado esquerdo

PL9984.41.12 Lado direito

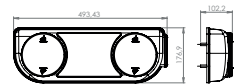

Exemplo de aplicação
Produto não disponível

CÓDIGO	DESCRIÇÃO	TENSÃO	LENTE	LADO	COR LENTE	REF. ORIGINAL	EMB.
PL2600.79.69	Com conector tipo original	LED BIVOLT	Acrílica	Direito	Bicolor	0308270335	01
PL2600.80.69	Com conector tipo original	LED BIVOLT	Acrílica	Esquerdo	Bicolor		01

CÓDIGO	DESCRIÇÃO	TENSÃO	LENTE	LADO	COR LENTE	EMB.
PL2600.61.69	Com cabos para adaptação	LED BIVOLT	Acrílica	Direito	Bicolor	01
PL2600.62.69	Com cabos para adaptação	LED BIVOLT	Acrílica	Esquerdo	Bicolor	01
REPOSIÇÃO	DESCRIÇÃO	TENSÃO	LENTE	COR	EMB.	
PL0820.00.65	Lanterna 3 funções direcional, freio e posição	LED BIVOLT	Acrílica	LED Amarelo e Vermelho	05	
PL0820.00.67	Lanterna 3 funções luz de ré, freio e posição	LED BIVOLT	Acrílica	LED Cristal e Vermelho	05	
PL0731.00.23	Triângulo retrorrefletor	-	Acrílica	Vermelho	10	
PL9984.42.13	Chicote conector lado esquerdo				10	
PL9984.41.12	Chicote conector lado direito				10	

PL 2602

Suporte traseiro LED Com lente cristal e triângulo retrorrefletor para implementos

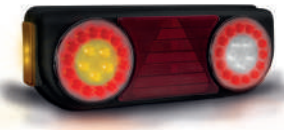

PL0820.21.65

Lanterna acesa

PL0820.21.67

Lanterna acesa

PL0731.00.23

PL9984.42.13 Lado esquerdo

PL9984.41.12 Lado direito

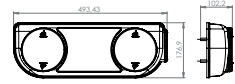

Exemplo de aplicação
Produto não disponível

CÓDIGO	DESCRIÇÃO	TENSÃO	LENTE	LADO	COR LENTE	EMB.
PL2602.79.69	Com conector tipo original	LED BIVOLT	Acrílica	Direito	Cristal	01
PL2602.80.69	Com conector tipo original	LED BIVOLT	Acrílica	Esquerdo	Cristal	01
REPOSIÇÃO	DESCRIÇÃO	TENSÃO	LENTE	COR	EMB.	
PL0820.21.65	Lanterna 3 funções direcional, freio e posição	LED BIVOLT	Cristal	LED Amarelo em Acrílico e Vermelho	05	
PL0820.21.67	Lanterna 3 funções luz de ré, freio e posição	LED BIVOLT	Cristal	LED Cristal em Acrílico e Vermelho	05	
PL0731.00.23	Triângulo retrorrefletor	-	Acrílica	Vermelho	10	
PL9984.42.13	Chicote conector lado esquerdo				10	
PL9984.41.12	Chicote conector lado direito				10	

PL 2604

Suporte traseiro Halo Light Com triângulo retrorrefletor para implementos



PL0818.00.65

Lanterna acesa

PL0818.00.67

Lanterna acesa

PL0731.00.23

PL9984.42.13 Lado esquerdo

PL9984.41.12 Lado direito

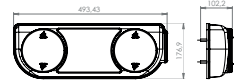

Exemplo de aplicação
Produto não disponível

CÓDIGO	DESCRIÇÃO	TENSÃO	LENTE	LADO	COR LENTE	EMB.
PL2604.79.69	Com conector tipo original	LED BIVOLT	Acrílica	Direito	Bicolor	01
PL2604.80.69	Com conector tipo original	LED BIVOLT	Acrílica	Esquerdo	Bicolor	01
REPOSIÇÃO	DESCRIÇÃO	TENSÃO	LENTE	COR	EMB.	
PL0818.00.65	Lanterna Halo Light 3 funções direcional, freio e posição	LED BIVOLT	Acrílica	LED Amarelo e Vermelho	05	
PL0818.00.67	Lanterna Halo Light 3 funções luz de ré, freio e posição	LED BIVOLT	Acrílica	LED Cristal e Vermelho	05	
PL0731.00.23	Triângulo retrorrefletor	-	Acrílica	Vermelho	10	
PL9984.42.13	Chicote conector lado esquerdo				10	
PL9984.41.12	Chicote conector lado direito				10	



PL 2102
Suporte traseiro com LED
Aplicação Noma e universal



Caixa mais fina

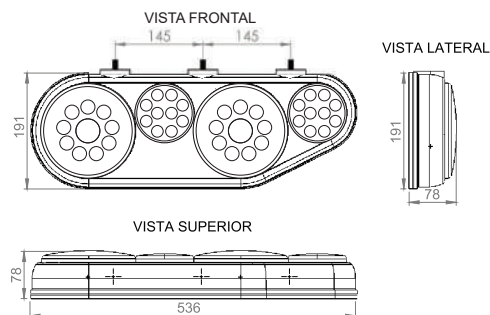

CÓDIGO	DESCRIÇÃO	TENSÃO	LADO	EMB.	
PL2102.77.69	Suporte traseiro	LED 24V	Direito	01	
PL2102.78.69	Suporte traseiro	LED 24V	Esquerdo	01	
CÓDIGO	DESCRIÇÃO	TENSÃO	LENTE	COR	EMB.
PL0780.24.63	Lanterna freio e posição	LED 24V	Acrílica	Vermelho	04
PL0782.00.61	Lanterna direcional	LED BIVOLT	Acrílica	Amarelo	01
PL0782.00.62	Lanterna luz de ré	LED BIVOLT	Acrílica	Cristal	01
PL0782.24.61	Lanterna direcional	LED 24V	Acrílica	Amarelo	01
PL0782.24.62	Lanterna luz de ré	LED 24V	Acrílica	Cristal	01
PL2102.61.17	Caixa para suporte traseiro - Lado direito				01
PL2102.62.17	Caixa para suporte traseiro - Lado esquerdo				01
PL9950.17.00	Chicote 2 vias para Faston 6,3mm				10
PL9951.37.00	Chicote 3 vias para Faston 6,3mm				10

PL 2104
Suporte traseiro com LED e triângulo
Aplicação Noma e universal



Caixa mais fina

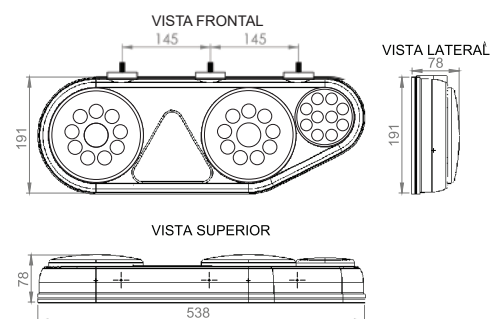

CÓDIGO	DESCRIÇÃO	TENSÃO	LADO	REF. ORIGINAL	EMB.
PL2104.75.69	Suporte traseiro	LED 24V	Direito	9205586	01
PL2104.76.69	Suporte traseiro	LED 24V	Esquerdo	9205585	01
CÓDIGO	DESCRIÇÃO	TENSÃO	LENTE	COR	EMB.
PL0780.24.63	Lanterna freio e posição	LED 24V	Acrílica	Vermelho	04
PL0782.00.61	Lanterna direcional	LED BIVOLT	Acrílica	Amarelo	01
PL0782.24.61	Lanterna direcional	LED 24V	Acrílica	Amarelo	01
PL0788.24.67	Lanterna luz de ré freio e posição	LED 24V	Acrílica	Bicolor	04
PL0790.00.23	Triângulo retrorefletor	-	Acrílica	Vermelho	10
PL2104.61.17	Caixa com triângulo para suporte traseiro - Lado direito				01
PL2104.62.17	Caixa com triângulo para suporte traseiro - Lado esquerdo				01
PL9950.17.00	Chicote 2 vias para Faston 6,3mm				10
PL9951.37.00	Chicote 3 vias para Faston 6,3mm				10

PL 2058

Suporte traseiro 10 LEDs com triângulo
Aplicação universal



CÓDIGO	DESCRIÇÃO	TENSÃO	LENTE	COR	LADO	EMB.
PL2058.65.70	Suporte traseiro	LED BIVOLT			Direito	01
PL2058.66.70	Suporte traseiro	LED BIVOLT			Esquerdo	01
CÓDIGO	DESCRIÇÃO	TENSÃO	LENTE	COR	EMB.	
PL0578.00.61	Lanterna lateral 66mm	LED BIVOLT	Acrílica	Amarelo	10	
PL0731.00.23	Triângulo retrorrefletor	-	Acrílica	Vermelho	10	
PL0756.23.04	Lanterna luz de ré	-	-	Fumê	10	
PL0760.00.61	Lanterna direcional	LED BIVOLT	Acrílica	Amarelo	01	
PL0760.00.63	Lanterna freio e posição	LED BIVOLT	Acrílica	Vermelho	01	
PL2000.61.17	Caixa para suporte traseiro - Lado direito				01	
PL2000.62.17	Caixa para suporte traseiro - Lado esquerdo				01	
PL9900.17.94	Soquete 1 polo universal				10	
PL9950.17.00	Chicote 2 vias para Faston 6,3mm				10	
PL9951.37.00	Chicote 3 vias para Faston 6,3mm				10	

PL 2066

Suporte traseiro 10 LEDs
Aplicação universal

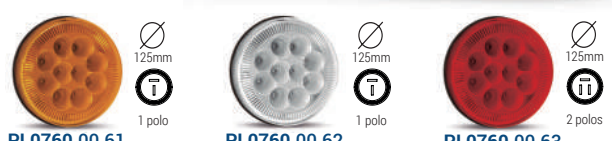

CÓDIGO	DESCRIÇÃO	TENSÃO	LENTE	COR	LADO	EMB.
PL2066.77.69	Suporte traseiro	LED BIVOLT			Direito	01
PL2066.78.69	Suporte traseiro	LED BIVOLT			Esquerdo	01
CÓDIGO	DESCRIÇÃO	TENSÃO	LENTE	COR	EMB.	
PL0578.00.61	Lanterna lateral 66mm	LED BIVOLT	Acrílica	Amarelo	10	
PL0760.00.61	Lanterna direcional	LED BIVOLT	Acrílica	Amarelo	01	
PL0760.00.62	Lanterna luz de ré	LED BIVOLT	Acrílica	Cristal	01	
PL0760.00.63	Lanterna freio e posição	LED BIVOLT	Acrílica	Vermelho	01	
PL2000.61.17	Caixa para suporte traseiro - Lado direito				01	
PL2000.62.17	Caixa para suporte traseiro - Lado esquerdo				01	
PL9950.17.00	Chicote 2 vias para Faston 6,3mm				10	
PL9951.37.00	Chicote 3 vias para Faston 6,3mm				10	

PL 2070

Suporte traseiro 10 LEDs
Aplicação universal

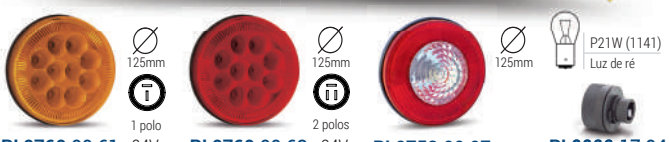

CÓDIGO	DESCRIÇÃO	TENSÃO	LADO	REF. ORIGINAL	EMB.
PL2070.33.69	Suporte traseiro	LED BIVOLT	Direito	210102747-P	01
PL2070.34.69	Suporte traseiro	LED BIVOLT	Esquerdo	210102748-P	01
CÓDIGO	DESCRIÇÃO	TENSÃO	LENTE	COR	EMB.
PL0578.00.61	Lanterna lateral 66mm	LED BIVOLT	Acrílica	Amarelo	10
PL0758.00.07	Lanterna luz de ré	-	-	Bicolor	10
PL0760.00.61	Lanterna direcional	LED BIVOLT	Acrílica	Amarelo	01
PL0760.00.63	Lanterna freio e posição	LED BIVOLT	Acrílica	Vermelho	01
PL2000.61.17	Caixa para suporte traseiro - Lado direito				01
PL2000.62.17	Caixa para suporte traseiro - Lado esquerdo				01
PL9900.17.94	Soquete 1 polo universal				10
PL9950.17.00	Chicote 2 vias para Faston 6,3mm				10
PL9951.37.00	Chicote 3 vias para Faston 6,3mm				10

PL 2076

Suporte traseiro 10 LEDs com triângulo
Aplicação universal



CÓDIGO	DESCRIÇÃO	TENSÃO	LADO	EMB.	
PL2076.75.69	Suporte traseiro	LED BIVOLT	Direito	01	
PL2076.76.69	Suporte traseiro	LED BIVOLT	Esquerdo	01	
CÓDIGO	DESCRIÇÃO	TENSÃO	LENTE	COR	EMB.
PL0578.00.61	Lanterna lateral 66mm	LED BIVOLT	Acrílica	Amarelo	10
PL0731.00.23	Triângulo retrorrefletor	-	Acrílica	Vermelho	10
PL0760.00.61	Lanterna direcional	LED BIVOLT	Acrílica	Amarelo	01
PL0760.00.62	Lanterna luz de ré	LED BIVOLT	Acrílica	Cristal	01
PL0760.00.63	Lanterna freio e posição	LED BIVOLT	Acrílica	Vermelho	01
PL2000.61.17	Caixa para suporte traseiro - Lado direito			01	
PL2000.62.17	Caixa para suporte traseiro - Lado esquerdo			01	
PL9950.17.00	Chicote 2 vias para Faston 6,3mm			10	
PL9951.37.00	Chicote 3 vias para Faston 6,3mm			10	



PL 2004
Suporte traseiro
Aplicação Guerra e universal



CÓDIGO	DESCRIÇÃO	LADO	REF. ORIGINAL	EMB.
PL2004.61.09	Suporte traseiro	Direito	5001009206009	01
PL2004.62.09	Suporte traseiro	Esquerdo	5001009207000	01



CÓDIGO	DESCRIÇÃO	LADO	COR	REF. ORIGINAL	EMB.
PL0536.00.01	Lanterna direcional	-	Amarelo	5001009213001	10
PL0536.00.02	Lanterna luz de ré	-	Cristal	5001009154009	10
PL0536.00.03	Lanterna posição e freio	-	Vermelho	5001009211008	10
PL0564.00.01	Lanterna lateral 85mm	-	Amarelo	-	10
PL0565.00.01	Lente para lanterna lateral	-	Amarelo	-	10
PL2004.61.17	Caixa para suporte traseiro	Direito	-	-	01
PL2004.62.17	Caixa para suporte traseiro	Esquerdo	-	-	01
PL9900.17.94	Soquete 1 polo universal	-	-	-	10
PL9950.17.00	Chicote 2 vias para Faston 6,3mm	-	-	-	10

CÓDIGO	DESCRIÇÃO	LADO	COR	REF. ORIGINAL	EMB.
PL0536.00.01	Lanterna direcional	-	Amarelo	5001009213001	10
PL0536.00.02	Lanterna luz de ré	-	Cristal	5001009154009	10
PL0536.00.03	Lanterna posição e freio	-	Vermelho	5001009211008	10
PL0564.00.01	Lanterna lateral 85mm	-	Amarelo	-	10
PL0565.00.01	Lente para lanterna lateral	-	Amarelo	-	10
PL2004.61.17	Caixa para suporte traseiro	Direito	-	-	01
PL2004.62.17	Caixa para suporte traseiro	Esquerdo	-	-	01
PL9900.17.94	Soquete 1 polo universal	-	-	-	10
PL9950.17.00	Chicote 2 vias para Faston 6,3mm	-	-	-	10

PL 2008
Suporte traseiro com lente lisa
Aplicação Guerra e universal



CÓDIGO	DESCRIÇÃO	LADO	REF. ORIGINAL	EMB.
PL2008.61.09	Suporte traseiro	Direito	-	01
PL2008.62.09	Suporte traseiro	Esquerdo	-	01



CÓDIGO	DESCRIÇÃO	LADO	COR	REF. ORIGINAL	EMB.
PL0586.00.01	Lanterna direcional com lente lisa	-	Amarelo	-	10
PL0586.00.02	Lanterna luz de ré com lente lisa	-	Cristal	-	10
PL0586.00.03	Lanterna posição e freio com lente lisa	-	Vermelho	-	10
PL0564.00.01	Lanterna lateral 85mm	-	Amarelo	-	10
PL0565.00.01	Lente para lanterna lateral	-	Amarelo	-	10
PL2004.61.17	Caixa para suporte traseiro	Direito	-	-	01
PL2004.62.17	Caixa para suporte traseiro	Esquerdo	-	-	01
PL9900.17.94	Soquete 1 polo universal	-	-	-	10
PL9950.17.00	Chicote 2 vias para Faston 6,3mm	-	-	-	10

CÓDIGO	DESCRIÇÃO	LADO	COR	REF. ORIGINAL	EMB.
PL0586.00.01	Lanterna direcional com lente lisa	-	Amarelo	-	10
PL0586.00.02	Lanterna luz de ré com lente lisa	-	Cristal	-	10
PL0586.00.03	Lanterna posição e freio com lente lisa	-	Vermelho	-	10
PL0564.00.01	Lanterna lateral 85mm	-	Amarelo	-	10
PL0565.00.01	Lente para lanterna lateral	-	Amarelo	-	10
PL2004.61.17	Caixa para suporte traseiro	Direito	-	-	01
PL2004.62.17	Caixa para suporte traseiro	Esquerdo	-	-	01
PL9900.17.94	Soquete 1 polo universal	-	-	-	10
PL9950.17.00	Chicote 2 vias para Faston 6,3mm	-	-	-	10

PL 2000
Suporte traseiro
Aplicação universal



CÓDIGO	DESCRIÇÃO	LADO	REF. ORIGINAL	EMB.
PL2000.61.09	Suporte traseiro	Direito	210102003-P	01
PL2000.62.09	Suporte traseiro	Esquerdo	210102004-P	01



CÓDIGO	DESCRIÇÃO	LADO	COR	REF. ORIGINAL	EMB.
PL0526.00.01	Lanterna direcional	-	Amarelo	-	10
PL0526.00.03	Lanterna posição e freio	-	Vermelho	-	10
PL0758.00.07	Lanterna luz de ré com refletivo	-	Bicolor	-	10
PL0526.21.01	Lanterna lateral 85mm	-	Amarelo	-	10
PL0531.00.01	Lente para lanterna lateral	-	Amarelo	-	10
PL2000.61.17	Caixa para suporte traseiro	Direito	-	-	01
PL2000.62.17	Caixa para suporte traseiro	Esquerdo	-	-	01
PL9900.17.94	Soquete 1 polo universal	-	-	-	10
PL9901.37.94	Soquete 2 polos universal	-	-	-	10
PL9950.17.00	Chicote 2 vias para Faston 6,3mm	-	-	-	10
PL9951.37.00	Chicote 3 vias para Faston 6,3mm	-	-	-	10

CÓDIGO	DESCRIÇÃO	LADO	COR	REF. ORIGINAL	EMB.
PL0526.00.01	Lanterna direcional	-	Amarelo	-	10
PL0526.00.03	Lanterna posição e freio	-	Vermelho	-	10
PL0758.00.07	Lanterna luz de ré com refletivo	-	Bicolor	-	10
PL0526.21.01	Lanterna lateral 85mm	-	Amarelo	-	10
PL0531.00.01	Lente para lanterna lateral	-	Amarelo	-	10
PL2000.61.17	Caixa para suporte traseiro	Direito	-	-	01
PL2000.62.17	Caixa para suporte traseiro	Esquerdo	-	-	01
PL9900.17.94	Soquete 1 polo universal	-	-	-	10
PL9901.37.94	Soquete 2 polos universal	-	-	-	10
PL9950.17.00	Chicote 2 vias para Faston 6,3mm	-	-	-	10
PL9951.37.00	Chicote 3 vias para Faston 6,3mm	-	-	-	10

PL 2000
Suporte traseiro com aba
Aplicação universal



CÓDIGO	DESCRIÇÃO	LADO	REF. ORIGINAL	EMB.
PL2000.63.09	Suporte traseiro com aba	Direito	210102001-P	01
PL2000.64.09	Suporte traseiro com aba	Esquerdo	210102002-P	01



CÓDIGO	DESCRIÇÃO	LADO	COR	REF. ORIGINAL	EMB.
PL0526.00.01	Lanterna direcional	-	Amarelo	-	10
PL0526.00.03	Lanterna posição e freio	-	Vermelho	-	10
PL0758.00.07	Lanterna luz de ré com refletivo	-	Bicolor	-	10
PL0526.21.01	Lanterna lateral 85mm	-	Amarelo	-	10
PL0531.00.01	Lente para lanterna lateral	-	Amarelo	-	10
PL2000.79.17	Caixa com aba sem refletor para suporte traseiro	Direito	-	-	01
PL2000.80.17	Caixa com aba sem refletor para suporte traseiro	Esquerdo	-	-	01
PL9900.17.94	Soquete 1 polo universal	-	-	-	10
PL9901.37.94	Soquete 2 polos universal	-	-	-	10
PL9950.17.00	Chicote 2 vias para Faston 6,3mm	-	-	-	10
PL9951.37.00	Chicote 3 vias para Faston 6,3mm	-	-	-	10

CÓDIGO	DESCRIÇÃO	LADO	COR	REF. ORIGINAL	EMB.
PL0526.00.01	Lanterna direcional	-	Amarelo	-	10
PL0526.00.03	Lanterna posição e freio	-	Vermelho	-	10
PL0758.00.07	Lanterna luz de ré com refletivo	-	Bicolor	-	10
PL0526.21.01	Lanterna lateral 85mm	-	Amarelo	-	10
PL0531.00.01	Lente para lanterna lateral	-	Amarelo	-	10
PL2000.79.17	Caixa com aba sem refletor para suporte traseiro	Direito	-	-	01
PL2000.80.17	Caixa com aba sem refletor para suporte traseiro	Esquerdo	-	-	01
PL9900.17.94	Soquete 1 polo universal	-	-	-	10
PL9901.37.94	Soquete 2 polos universal	-	-	-	10
PL9950.17.00	Chicote 2 vias para Faston 6,3mm	-	-	-	10
PL9951.37.00	Chicote 3 vias para Faston 6,3mm	-	-	-	10



PL 2038

Suporte traseiro com triângulo e ré fumê
Aplicação universal



CÓDIGO	DESCRIÇÃO	LADO	EMB.
PL2038.65.10	Suporte traseiro	Direito	01
PL2038.66.10	Suporte traseiro	Esquerdo	01

PL0756.23.01 **PL0756.23.03** **PL0756.23.04** **PL9900.17.94** - 1 P
PL9901.37.94 - 2 P

PL0526.21.01 **PL0531.00.01** **PL0731.00.23** **PL2000.61.17** - LD
PL2000.62.17 - LE

PL9950.17.00 **PL9951.37.00**

CÓDIGO	DESCRIÇÃO	LENTE	LADO	COR	EMB.
PL0526.21.01	Lanterna lateral 85mm	-	-	Amarelo	10
PL0531.00.01	Lente para lanterna lateral	-	-	Amarelo	10
PL0731.00.23	Triângulo retrorrefletor	Acrílica	-	Vermelho	10
PL0756.23.01	Lanterna direcional lente lisa	-	-	Amarelo	10
PL0756.23.03	Lanterna posição e freio lente lisa	-	-	Vermelho	10
PL0756.23.04	Lanterna luz de ré lente lisa	-	-	Fumê	10
PL2000.61.17	Caixa para suporte traseiro	-	Direito	-	01
PL2000.62.17	Caixa para suporte traseiro	-	Esquerdo	-	01
PL9900.17.94	Soquete 1 polo universal	-	-	-	10
PL9901.37.94	Soquete 2 polos universal	-	-	-	10
PL9950.17.00	Chicote 2 vias para Faston 6,3mm	-	-	-	10
PL9951.37.00	Chicote 3 vias para Faston 6,3mm	-	-	-	10

PL 2040

Suporte traseiro
Aplicação universal



CÓDIGO	DESCRIÇÃO	LADO	EMB.
PL2040.61.10	Suporte traseiro	Direito	01
PL2040.62.10	Suporte traseiro	Esquerdo	01

PL0756.23.01 **PL0756.23.03** **PL0758.00.08** **PL9900.17.94** - 1 P
PL9901.37.94 - 2 P

PL0526.21.01 **PL0531.00.01** **PL2000.61.17** - LD
PL2000.62.17 - LE

PL9950.17.00 **PL9951.37.00**

CÓDIGO	DESCRIÇÃO	LADO	COR	EMB.
PL0526.21.01	Lanterna lateral 85mm	-	Amarelo	10
PL0531.00.01	Lente para lanterna lateral	-	Amarelo	10
PL0756.23.01	Lanterna direcional lente lisa	-	Amarelo	10
PL0756.23.03	Lanterna posição e freio lente lisa	-	Vermelho	10
PL0758.00.08	Lanterna luz de ré com refletivo	-	Bicolor	10
PL2000.61.17	Caixa para suporte traseiro	Direito	-	01
PL2000.62.17	Caixa para suporte traseiro	Esquerdo	-	01
PL9900.17.94	Soquete 1 polo universal	-	-	10
PL9901.37.94	Soquete 2 polos universal	-	-	10
PL9950.17.00	Chicote 2 vias para Faston 6,3mm	-	-	10
PL9951.37.00	Chicote 3 vias para Faston 6,3mm	-	-	10

PL 2048

Suporte traseiro com triângulo
Aplicação universal



CÓDIGO	DESCRIÇÃO	LADO	EMB.
PL2048.65.09	Suporte traseiro	Direito	01
PL2048.66.09	Suporte traseiro	Esquerdo	01

PL0756.23.01 **PL0756.23.02** **PL0756.23.03** **PL9900.17.94** - 1 P
PL9901.37.94 - 2 P

PL0526.21.01 **PL0531.00.01** **PL0731.00.23** **PL2000.61.17** - LD
PL2000.62.17 - LE

PL9950.17.00 **PL9951.37.00**

CÓDIGO	DESCRIÇÃO	LENTE	LADO	COR	EMB.
PL0526.21.01	Lanterna lateral 85mm	-	-	Amarelo	10
PL0531.00.01	Lente para lanterna lateral	-	-	Amarelo	10
PL0731.00.23	Triângulo retrorrefletor	Acrílica	-	Vermelho	10
PL0756.23.01	Lanterna direcional lente lisa	-	-	Amarelo	10
PL0756.23.02	Lanterna luz de ré lente lisa	-	-	Cristal	10
PL0756.23.03	Lanterna posição e freio lente lisa	-	-	Vermelho	10
PL2000.61.17	Caixa para suporte traseiro	-	Direito	-	01
PL2000.62.17	Caixa para suporte traseiro	-	Esquerdo	-	01
PL9900.17.94	Soquete 1 polo universal	-	-	-	10
PL9901.37.94	Soquete 2 polos universal	-	-	-	10
PL9950.17.00	Chicote 2 vias para Faston 6,3mm	-	-	-	10
PL9951.37.00	Chicote 3 vias para Faston 6,3mm	-	-	-	10

PL 2050

Suporte traseiro com luz de ré vermelho e cristal
Aplicação universal



CÓDIGO	DESCRIÇÃO	LADO	REF. ORIGINAL	EMB.
PL2050.61.09	Suporte traseiro	Direito	210102691-P	01
PL2050.62.09	Suporte traseiro	Esquerdo	210102692-P	01

PL0756.23.01 **PL0756.23.03** **PL0758.00.07** **PL9900.17.94** - 1 P
PL9901.37.94 - 2 P

PL0526.21.01 **PL0531.00.01** **PL2000.61.17** - LD
PL2000.62.17 - LE

PL9950.17.00 **PL9951.37.00**

CÓDIGO	DESCRIÇÃO	LADO	COR	EMB.
PL0526.21.01	Lanterna lateral 85mm	-	Amarelo	10
PL0531.00.01	Lente para lanterna lateral	-	Amarelo	10
PL0756.23.01	Lanterna direcional lente lisa	-	Amarelo	10
PL0756.23.03	Lanterna posição e freio lente lisa	-	Vermelho	10
PL0758.00.07	Lanterna luz de ré com refletivo	-	Bicolor	10
PL2000.61.17	Caixa para suporte traseiro	Direito	-	01
PL2000.62.17	Caixa para suporte traseiro	Esquerdo	-	01
PL9900.17.94	Soquete 1 polo universal	-	-	10
PL9901.37.94	Soquete 2 polos universal	-	-	10
PL9950.17.00	Chicote 2 vias para Faston 6,3mm	-	-	10
PL9951.37.00	Chicote 3 vias para Faston 6,3mm	-	-	10



PL 2054

Suporte traseiro com luz de ré vermelho e cristal e aba
Aplicação universal



CÓDIGO	DESCRIÇÃO	LADO	REF. ORIGINAL	EMB.
PL2054.63.09	Suporte traseiro com aba sem refletor	Direito	210102695-P	01
PL2054.64.09	Suporte traseiro com aba sem refletor	Esquerdo	210102696-P	01

PL9900.17.94 - 1 P
PL9901.37.94 - 2 P
 P21W (1141)
 Freio
 Luz de ré
 Direcional
 125mm
PL0526.21.01 **PL0531.00.01**
 85mm
PL2000.79.17 - LD
PL2000.80.17 - LE
 P21/5W (1034)
 Freio e Posição
PL9950.17.00 **PL9951.37.00**
 R5W (67)
 Posição

CÓDIGO	DESCRIÇÃO	LADO	COR	EMB.
PL0526.21.01	Lanterna lateral 85mm	-	Amarelo	10
PL0531.00.01	Lente para lanterna lateral	-	Amarelo	10
PL0756.23.01	Lanterna direcional lente lisa	-	Amarelo	10
PL0756.23.03	Lanterna posição e freio lente lisa	-	Vermelho	10
PL0758.00.07	Lanterna luz de ré com refletivo	-	Bicolor	10
PL2000.79.17	Caixa com aba sem refletor para suporte traseiro Direito	-	-	01
PL2000.80.17	Caixa com aba sem refletor para suporte traseiro Esquerdo	-	-	01
PL9900.17.94	Soquete 1 polo universal	-	-	10
PL9901.37.94	Soquete 2 polos universal	-	-	10
PL9950.17.00	Chicote 2 vias para Faston 6,3mm	-	-	10
PL9951.37.00	Chicote 3 vias para Faston 6,3mm	-	-	10

PL 2090

Suporte traseiro
Aplicação universal



CÓDIGO	DESCRIÇÃO	LADO	EMB.
PL2090.61.09	Suporte traseiro	Direito	01
PL2090.62.09	Suporte traseiro	Esquerdo	01

PL1354.00.01 **PL1354.00.03** **PL1350.00.07**
 125mm
PL9900.17.94 - 1 P
PL9901.37.94 - 2 P
 P21W (1141)
 Freio
 Luz de ré
 Direcional
PL0526.21.01 **PL0531.00.01**
 85mm
PL2000.61.17 - LD
PL2000.62.17 - LE
 P21/5W (1034)
 Freio e Posição
PL9950.17.00 **PL9951.37.00**
 R5W (67)
 Posição

CÓDIGO	DESCRIÇÃO	LADO	COR	EMB.
PL0526.21.01	Lanterna lateral 85mm	-	Amarelo	10
PL0531.00.01	Lente para lanterna lateral	-	Amarelo	10
PL1350.00.07	Lanterna luz de ré	-	Bicolor	10
PL1354.00.01	Lanterna direcional	-	Amarelo	10
PL1354.00.03	Lanterna posição e freio	-	Vermelho	10
PL2000.61.17	Caixa para suporte traseiro	Direito	-	01
PL2000.62.17	Caixa para suporte traseiro	Esquerdo	-	01
PL9900.17.94	Soquete 1 polo universal	-	-	10
PL9901.37.94	Soquete 2 polos universal	-	-	10
PL9950.17.00	Chicote 2 vias para Faston 6,3mm	-	-	10
PL9951.37.00	Chicote 3 vias para Faston 6,3mm	-	-	10

PL 2056

Suporte traseiro com luz de ré cristal
Aplicação universal



CÓDIGO	DESCRIÇÃO	LADO	EMB.
PL2056.61.09	Suporte traseiro	Direito	01
PL2056.62.09	Suporte traseiro	Esquerdo	01

PL0756.23.01 **PL0756.23.02** **PL0756.23.03** **PL9901.37.94** - 2 P
 125mm
 P21W (1141)
 Freio
 Luz de ré
 Direcional
PL0526.21.01 **PL0531.00.01**
 85mm
PL2000.61.17 - LD
PL2000.62.17 - LE
 P21/5W (1034)
 Freio e Posição
PL9950.17.00 **PL9951.37.00**
 R5W (67)
 Posição

CÓDIGO	DESCRIÇÃO	LADO	COR	EMB.
PL0526.21.01	Lanterna lateral 85mm	-	Amarelo	10
PL0531.00.01	Lente para lanterna lateral	-	Amarelo	10
PL0756.23.01	Lanterna direcional lente lisa	-	Amarelo	10
PL0756.23.02	Lanterna luz de ré lente lisa	-	Cristal	10
PL0756.23.03	Lanterna posição e freio lente lisa	-	Vermelho	10
PL2000.61.17	Caixa para suporte traseiro	Direito	-	01
PL2000.62.17	Caixa para suporte traseiro	Esquerdo	-	01
PL9900.17.94	Soquete 1 polo universal	-	-	10
PL9901.37.94	Soquete 2 polos universal	-	-	10
PL9950.17.00	Chicote 2 vias para Faston 6,3mm	-	-	10
PL9951.37.00	Chicote 3 vias para Faston 6,3mm	-	-	10

PL 2010

Suporte traseiro polivalente
Aplicação Facchini



CÓDIGO	DESCRIÇÃO	LADO	EMB.
PL2010.60.09	Suporte traseiro polivalente	Bilateral	01

PL0582.00.01 **PL0582.00.02** **PL0582.00.23**
 125mm
PL0526.21.01 **PL0531.00.01**
 85mm
PL9900.17.94 - 1 P
PL9901.37.94 - 2 P
 P21W (1141)
 Freio
 Luz de ré
 Direcional
PL9950.17.00 **PL9951.37.00**
 R5W (67)
 Posição
 Acompanha kit de fixação superior/traseira.

CÓDIGO	DESCRIÇÃO	LENTE	LADO	COR	EMB.
PL0526.21.01	Lanterna lateral 85mm	-	-	Amarelo	10
PL0531.00.01	Lente para lanterna lateral	-	-	Amarelo	10
PL0582.00.01	Lanterna direcional lente lisa	-	-	Amarelo	10
PL0582.00.02	Lanterna luz de ré lente lisa	-	-	Cristal	10
PL0582.00.23	Lanterna posição e freio lente lisa	Acrílico	-	Vermelho	10
PL9900.17.94	Soquete 1 polo universal	-	-	-	10
PL9901.37.94	Soquete 2 polos universal	-	-	-	10
PL9950.17.00	Chicote 2 vias para Faston 6,3mm	-	-	-	10
PL9951.37.00	Chicote 3 vias para Faston 6,3mm	-	-	-	10

PL 2006

Suporte traseiro polivalente
Aplicação Facchini



CÓDIGO	DESCRIÇÃO	LADO	EMB.
PL2006.60.09	Suporte traseiro polivalente 1ª geração	Bilateral	01

 PL0526.21.01	 PL0562.00.02	 PL0562.00.23	 125mm  P21W (1141) Freio Luz de ré Direcional  P21/5W (1034) Freio e Posição  R5W (67) Posição
 85mm	 PL0531.00.01	 PL9900.17.94 - 1 P PL9901.37.94 - 2 P	

 PL9950.17.00  PL9951.37.00
Acompanha kit de fixação superior/traseira.

CÓDIGO	DESCRIÇÃO	LENTE	LADO	COR	EMB.
PL0526.21.01	Lanterna lateral 85mm	-	-	Amarelo	10
PL0531.00.01	Lente para lanterna lateral	-	-	Amarelo	10
PL0562.00.01	Lanterna direcional 1ª geração	-	-	Amarelo	10
PL0562.00.02	Lanterna luz de ré 1ª geração	-	-	Cristal	10
PL0562.00.23	Lanterna posição e freio 1ª geração Acrílico	-	-	Vermelho	10
PL9900.17.94	Soquete 1 polo universal	-	-	-	10
PL9901.37.94	Soquete 2 polos universal	-	-	-	10
PL9950.17.00	Chicote 2 vias para Faston 6,3mm	-	-	-	10
PL9951.37.00	Chicote 3 vias para Faston 6,3mm	-	-	-	10



CÓDIGO	DESCRIÇÃO	LADO	EMB.
PL2006.59.09	Suporte traseiro polivalente 2ª geração	Bilateral	01

 PL0526.21.01	 PL0558.00.02	 PL0558.00.03	 125mm  P21W (1141) Freio Luz de ré Direcional  P21/5W (1034) Freio e Posição  R5W (67) Posição
 85mm	 PL0531.00.01	 PL9900.17.94 - 1 P PL9901.37.94 - 2 P	

 PL9950.17.00  PL9951.37.00
Acompanha kit de fixação superior/traseira.

CÓDIGO	DESCRIÇÃO	LADO	COR	EMB.
PL0526.21.01	Lanterna lateral 85mm	-	Amarelo	10
PL0531.00.01	Lente para lanterna lateral	-	Amarelo	10
PL0558.00.01	Lanterna direcional 2ª geração	-	Amarelo	10
PL0558.00.02	Lanterna luz de ré 2ª geração	-	Cristal	10
PL0558.00.03	Lanterna posição e freio 2ª geração	-	Vermelho	10
PL9900.17.94	Soquete 1 polo universal	-	-	10
PL9901.37.94	Soquete 2 polos universal	-	-	10
PL9950.17.00	Chicote 2 vias para Faston 6,3mm	-	-	10
PL9951.37.00	Chicote 3 vias para Faston 6,3mm	-	-	10

PL 0719

Conjunto de lentes para lanterna traseira universal
Aplicação Rossetti, tanques, furgões, carretas e adaptações

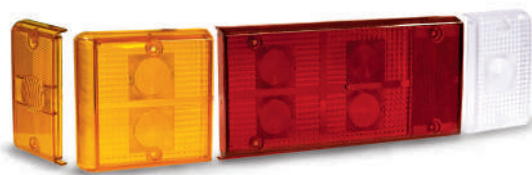

PL0719.00.09

CÓDIGO	DESCRIÇÃO	LENTE	COR	EMB.
PL0719.00.09	Conjunto de lentes para lanterna PL0718	-	-	05

PL 0570



Lanterna traseira
Aplicação Universal



PL0570.21.05

PL0571.21.05

CÓDIGO	DESCRIÇÃO	COR	EMB.
PL0570.21.05	Com lente alta	Amarelo e Vermelho	02
REPOSIÇÃO	DESCRIÇÃO <th>COR</th> <th>EMB.</th>	COR	EMB.
PL0571.21.05	Lente para lanterna PL0570	Amarelo e Vermelho	05

 P21W (1141)
 Freio
 Direcional
 Posição
 P21/5W (1034)
 Freio e Posição
 Direcional e
 Posição

PL 9960

Simulador de carga para instalação de lanternas LED



PL9960.00.00

COR	FUNÇÃO
---	TERRA (-)
---	POSIÇÃO D
---	LUZ DE RÉ
---	DIRECIONAL D
---	FREIO
---	DIRECIONAL E
---	POSIÇÃO E

- Uso bivolt 12 - 24V. Aplicação somente em corrente contínua;
- Proteção e estabilidade de sinalização;
- Carcaça selada a prova d'água;
- Fácil instalação com cabo 7 vias.

Para conectar na tomada 7 pinos do cabo principal do kit elétrico de acordo com norma 1185.

Simulador de carga eletrônico para implementação de lanternas LED em veículos pesados e semi-pesados.

Com correção de reconhecimento pelo veículo e estabilidade da luminosidade.

CÓDIGO	DESCRIÇÃO	EMB.
PL9960.00.00	Simulador de carga multifunção para lanternas LED	10



PL 9964

Suporte de placa de identificação veicular
Multifunção

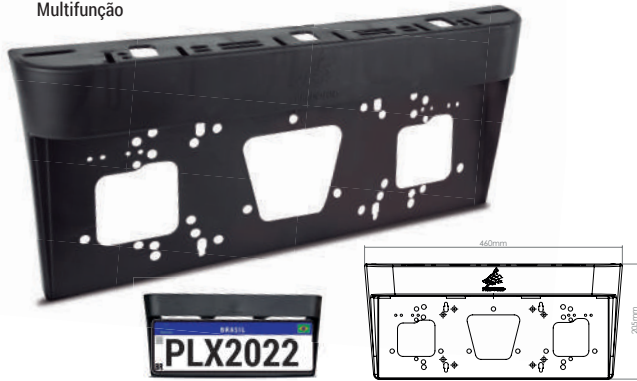

Também aplicável para lanternas



CÓDIGO	DESCRIÇÃO	EMB.
PL9964.19.17	Suporte de placa de identificação veicular	06

PL 0731

Triângulo retrorrefletor em acrílico



Com parafuso de fixação 2 ou 3 furos

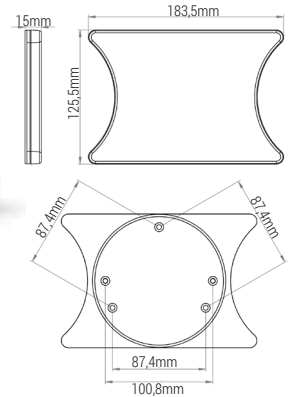

CÓDIGO	DESCRIÇÃO	LENTE	COR	EMB.
PL0731.00.23	Triângulo retrorrefletor	Acrílica	Vermelho	10

PL 9966

Suporte de placa de painéis de segurança

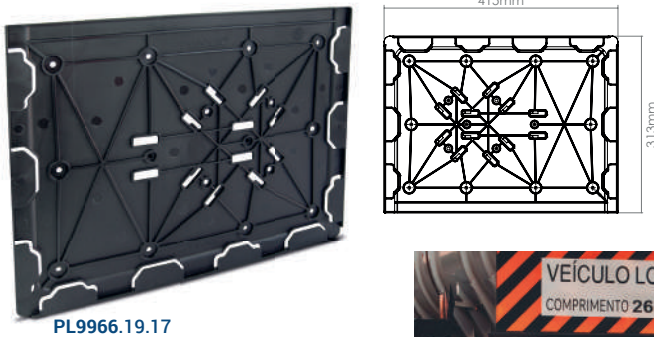

PL9966.19.17



PL9970.19.17



CÓDIGO	DESCRIÇÃO	EMB.
PL9966.19.17	Suporte de placa de Painéis de Segurança	15
REPOSIÇÃO	DESCRIÇÃO	EMB.
PL9970.19.17	Aba de fixação para suporte de placa PL9966 e PL9968	30

PL 0790

Triângulo retrorrefletor em acrílico

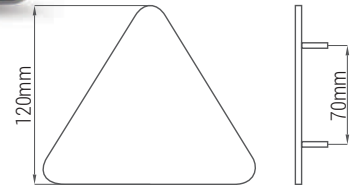

CÓDIGO	DESCRIÇÃO	LENTE	COR	EMB.
PL0790.00.23	Triângulo retrorrefletor	Acrílica	Vermelho	10

PL 9968

Suporte de placa de rótulos de risco



PL9968.19.17



PL9970.19.17



CÓDIGO	DESCRIÇÃO	EMB.
PL9968.19.17	Suporte de placa de Rótulos de risco	15
REPOSIÇÃO	DESCRIÇÃO	EMB.
PL9970.19.17	Aba de fixação para suporte de placa PL9966 e PL9968	30

PL 0994

Triângulo retrorrefletor em acrílico

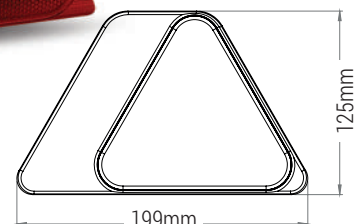
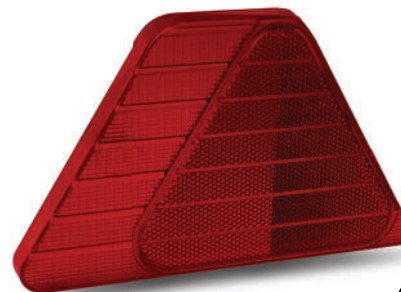

CÓDIGO	DESCRIÇÃO	LENTE	LADO	EMB.
PL0994.01.23	Triângulo retrorrefletor para suporte PL2700	Acrílica	Direito	04
PL0994.02.23	Triângulo retrorrefletor para suporte PL2700	Acrílica	Esquerdo	04



PL 0806

Lanternas Halo Light com 02 funções

LED BIVOLT

LNHA HALO LIGHT™



PL0806.12.65 - 12V
PL0806.24.65 - 24V

PL0806.12.67 - 12V
PL0806.24.67 - 24V

PL0806.12.63 - 12V
PL0806.24.63 - 24V



PL9950.17.00

PL9951.37.00

CÓDIGO	DESCRIÇÃO	TENSÃO	LENTE	COR	EMB.
PL0806.12.65	Lanterna direcional e posição	LED 12V	Acrílica	Vermelho e Amarelo	01
PL0806.12.67	Lanterna luz de ré e posição	LED 12V	Acrílica	Vermelho e Cristal	01
PL0806.12.63	Lanterna freio e posição	LED 12V	Acrílica	Vermelho	01
PL0806.24.65	Lanterna direcional e posição	LED 24V	Acrílica	Vermelho e Amarelo	01
PL0806.24.67	Lanterna luz de ré e posição	LED 24V	Acrílica	Vermelho e Cristal	01
PL0806.24.63	Lanterna freio e posição	LED 24V	Acrílica	Vermelho	01

REPOSIÇÃO	DESCRIÇÃO	EMB.
PL9950.17.00	Chicote 2 vias com guarda pó para Faston 6,3mm	10
PL9951.37.00	Chicote 3 vias com guarda pó para Faston 6,3mm	10

PL 0808

Lanternas Halo Light com 03 funções

LED BIVOLT

LNHA HALO LIGHT™



PL0808.12.65 - 12V
PL0808.24.65 - 24V

PL0808.12.67 - 12V
PL0808.24.67 - 24V



PL9950.17.00

PL9951.37.00

CÓDIGO	DESCRIÇÃO	TENSÃO	LENTE	COR	EMB.
PL0808.12.65	Lanterna direcional, freio e posição	LED 12V	Acrílica	Vermelho e Amarelo	01
PL0808.12.67	Lanterna luz de ré, freio e posição	LED 12V	Acrílica	Vermelho e Cristal	01
PL0808.24.65	Lanterna direcional, freio e posição	LED 24V	Acrílica	Vermelho e Amarelo	01
PL0808.24.67	Lanterna luz de ré, freio e posição	LED 24V	Acrílica	Vermelho e Cristal	01

REPOSIÇÃO	DESCRIÇÃO	EMB.
PL9950.17.00	Chicote 2 vias com guarda pó para Faston 6,3mm	10
PL9951.37.00	Chicote 3 vias com guarda pó para Faston 6,3mm	10

PL 0818

Lanternas Halo Light com 3 funções

LED BIVOLT

LNHA HALO LIGHT™



PL0818.00.65

PL0818.00.67

PL0818.00.69



Exemplos de aplicação. Produtos não disponíveis.

CÓDIGO	DESCRIÇÃO	TENSÃO	LENTE	COR	EMB.
PL0818.00.65	Lanterna direcional, freio e posição	LED BIVOLT	Acrílica	Vermelho e Amarelo	05
PL0818.00.67	Lanterna luz de ré, freio e posição	LED BIVOLT	Acrílica	Vermelho e Cristal	05
PL0818.00.69	Lanterna direcional, luz de ré, freio e posição	LED BIVOLT	Acrílica	Tricolor	05

PL 0820

Lanternas LED com 19 LEDs Bivolt
Aplicação universal

LED BIVOLT

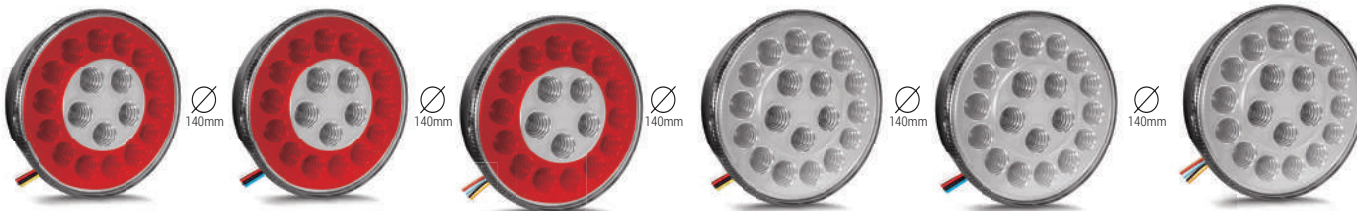

PL0820.00.65

PL0820.00.67

PL0820.00.69

PL0820.21.65

PL0820.21.67

PL0820.21.69



CÓDIGO	DESCRIÇÃO	TENSÃO	LENTE	COR	EMB.
PL0820.00.65	Lanterna 3 funções direcional, freio e posição	LED BIVOLT	Acrílica	Vermelho e Amarelo	05
PL0820.00.67	Lanterna 3 funções luz de ré, freio e posição	LED BIVOLT	Acrílica	Vermelho e Cristal	05
PL0820.00.69	Lanterna 4 funções direcional, luz de ré, freio e posição	LED BIVOLT	Acrílica	Tricolor	05

CÓDIGO	DESCRIÇÃO	TENSÃO	LENTE	COR	EMB.
PL0820.21.65	Lanterna 3 funções direcional, freio e posição	LED BIVOLT	Cristal em Acrílico	Vermelho e Amarelo	05
PL0820.21.67	Lanterna 3 funções luz de ré, freio e posição	LED BIVOLT	Cristal em Acrílico	Vermelho e Cristal	05
PL0820.21.69	Lanterna 4 funções direcional, luz de ré, freio e posição	LED BIVOLT	Cristal em Acrílico	Tricolor	05



PL 0782

Lanterna com 10 LEDs
para suporte traseiro aplicação Noma e Librelato

LED



PL9950.17.00



PL9951.37.00

CÓDIGO	DESCRIÇÃO	TENSÃO	LENTE	COR	EMB.
PL0782.00.61	Lanterna direcional	LED BIVOLT	Acrílica	Amarelo	01
PL0782.00.62	Lanterna luz de ré	LED BIVOLT	Acrílica	Cristal	01
PL0782.00.63	Lanterna posição e freio	LED BIVOLT	Acrílica	Vermelho	01
REPOSIÇÃO	DESCRIÇÃO				EMB.
PL9950.17.00	Chicote 2 vias com guarda pó para Faston 6,3mm				10
PL9951.37.00	Chicote 3 vias com guarda pó para Faston 6,3mm				10

PL 0796

Lanterna com 10 LEDs
para suporte traseiro aplicação Librelato

LED24V



PL9950.17.00



PL9951.37.00

CÓDIGO	DESCRIÇÃO	TENSÃO	LENTE	COR	REF. ORIGINAL	EMB.
PL0796.24.61	Lanterna direcional	LED24V	Acrílica	Amarelo	9701630	05
PL0796.24.62	Lanterna luz de ré	LED24V	Acrílica	Cristal	9513079	05
PL0796.24.63	Lanterna posição e freio	LED24V	Acrílica	Vermelho	9513082	05
REPOSIÇÃO	DESCRIÇÃO					EMB.
PL9950.17.00	Chicote 2 vias com guarda pó para Faston 6,3mm					10
PL9951.37.00	Chicote 3 vias com guarda pó para Faston 6,3mm					10

PL 0780

Lanterna com 10 LEDs 2 funções
para suporte traseiro aplicação Noma

LED24V



PL0780.24.63 - 24V

155mm

2 polos



PL9951.37.00

CÓDIGO	DESCRIÇÃO	TENSÃO	LENTE	COR	EMB.
PL0780.24.63	Lanterna posição e freio	LED24V	Acrílica	Vermelho	04
REPOSIÇÃO	DESCRIÇÃO				EMB.
PL9951.37.00	Chicote 3 vias com guarda pó para Faston 6,3mm				10

PL 0798

Lanterna com 10 LEDs
para suporte traseiro aplicação Librelato

LED24V



PL0798.24.61

Lanterna acesa

PL0798.24.63

Lanterna acesa



PL9950.17.00



PL9951.37.00

CÓDIGO	DESCRIÇÃO	TENSÃO	LENTE	COR	REF. ORIGINAL	EMB.
PL0798.24.61	Lanterna direcional	LED24V	Acrílica	Vermelho	9701075	05
PL0798.24.63	Lanterna posição e freio	LED24V	Acrílica	Amarelo	9701074	05
REPOSIÇÃO	DESCRIÇÃO					EMB.
PL9950.17.00	Chicote 2 vias com guarda pó para Faston 6,3mm					10
PL9951.37.00	Chicote 3 vias com guarda pó para Faston 6,3mm					10

PL 0788

Lanterna com 10 LEDs 3 funções
para suporte traseiro aplicação Noma

LED24V



PL0788.24.67 - 24V

155mm

3 polos

CÓDIGO	DESCRIÇÃO	TENSÃO	LENTE	COR	EMB.
PL0788.24.67	Lanterna luz de ré, posição e freio	LED24V	Acrílica	Vermelho e cristal	04

PL 0800

Lanterna com 4 LEDs para suporte traseiro tipo Librelato

LED24V



PL0800.00.62 - 24V

75mm

1 polo



PL9946.17.00

CÓDIGO	DESCRIÇÃO	TENSÃO	LENTE	COR	REF. ORIGINAL	EMB.
PL0800.00.62	Lanterna luz de ré	LED24V	Acrílica	Cristal	9701076	10
REPOSIÇÃO	DESCRIÇÃO					EMB.
PL9946.17.00	Chicote universal com conector ultra seal 2 vias					10



PL 0760

LED BIVOLT

Lanterna com 10 LEDs
para suporte traseiro aplicação universal



PL0760.00.61

PL0760.00.62

PL0760.00.63



PL9950.17.00



PL9951.37.00

CÓDIGO	DESCRIÇÃO	TENSÃO	LENTE	COR	EMB.
PL0760.00.61	Lanterna direcional	LED BIVOLT	Acrílica	Amarelo	01
PL0760.00.62	Lanterna luz de ré	LED BIVOLT	Acrílica	Cristal	01
PL0760.00.63	Lanterna posição e freio	LED BIVOLT	Acrílica	Vermelho	01

REPOSIÇÃO	DESCRIÇÃO	EMB.
PL9950.17.00	Chicote 2 vias com guarda pó para Faston 6,3mm	10
PL9951.37.00	Chicote 3 vias com guarda pó para Faston 6,3mm	10

PL 0762

LED BIVOLT

Lanterna com 10 LEDs
para suporte traseiro aplicação universal



PL0762.00.61

PL0762.00.62

PL0762.00.63



PL9950.17.00



PL9951.37.00

CÓDIGO	DESCRIÇÃO	TENSÃO	LENTE	COR	EMB.
PL0762.00.61	Lanterna direcional	LED BIVOLT	Acrílica	Amarelo	01
PL0762.00.62	Lanterna luz de ré	LED BIVOLT	Acrílica	Cristal	01
PL0762.00.63	Lanterna posição e freio	LED BIVOLT	Acrílica	Vermelho	01

REPOSIÇÃO	DESCRIÇÃO	EMB.
PL9950.17.00	Chicote 2 vias com guarda pó para Faston 6,3mm	10
PL9951.37.00	Chicote 3 vias com guarda pó para Faston 6,3mm	10

PL 0756

Lanterna com lente lisa
aplicação ônibus e implementos



PL0756.23.01

PL0756.23.02

PL0756.23.03

PL0756.23.04



Disponível
Saiba mais na página 23



PL9900.17.94

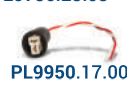

PL9950.17.00



PL9951.37.00

CÓDIGO	DESCRIÇÃO	COR	REF. ORIGINAL	EMB.
PL0756.23.01	Lanterna direcional	Amarelo	213000113	10
PL0756.23.02	Lanterna luz de ré	Cristal	-	10
PL0756.23.03	Lanterna posição e freio	Vermelho	213000112	10
PL0756.23.04	Lanterna luz de ré	Fumê	-	10

REPOSIÇÃO	DESCRIÇÃO	EMB.
PL9900.17.94	Soquete 1 polo universal	10
PL9901.37.94	Soquete 2 polos universal	10
PL9950.17.00	Chicote 2 vias com guarda pó para Faston 6,3mm	10
PL9951.37.00	Chicote 3 vias com guarda pó para Faston 6,3mm	10

PL 0758

Lanterna com retrorrefletor
aplicação ônibus e implementos



PL0758.00.07

PL0758.00.08



Disponível
Saiba mais na página 23

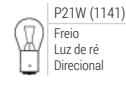

PL9950.17.00

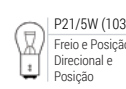

PL9951.37.00

CÓDIGO	DESCRIÇÃO	COR	REF. ORIGINAL	EMB.
PL0758.00.07	Lanterna luz de ré	Vermelho e cristal	213000114	10
PL0758.00.08	Lanterna luz de ré	Vermelho e fumê	-	10

REPOSIÇÃO	DESCRIÇÃO	EMB.
PL9900.17.94	Soquete 1 polo universal	10
PL9901.37.94	Soquete 2 polos universal	10
PL9950.17.00	Chicote 2 vias com guarda pó para Faston 6,3mm	10
PL9951.37.00	Chicote 3 vias com guarda pó para Faston 6,3mm	10

PL 1354

Lanterna traseira com fixação frontal
aplicação ônibus e implementos



PL1354.00.01

PL1354.00.02

PL1354.00.03



Disponível
Saiba mais na página 23

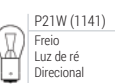

PL9950.17.00

CÓDIGO	DESCRIÇÃO	COR	REF. ORIGINAL	EMB.
PL1354.00.01	Lanterna direcional	Amarelo	6233239M91	10
PL1354.00.02	Lanterna luz de ré	Cristal	-	10
PL1354.00.03	Lanterna posição e freio	Vermelho	6233240M91	10

REPOSIÇÃO	DESCRIÇÃO	EMB.
PL9900.17.94	Soquete 1 polo universal	10
PL9901.37.94	Soquete 2 polos universal	10
PL9950.17.00	Chicote 2 vias com guarda pó para Faston 6,3mm	10
PL9951.37.00	Chicote 3 vias com guarda pó para Faston 6,3mm	10

PL 0582

Lanterna com lente lisa aplicação ônibus e implementos



PL0582.00.01

PL0582.00.02

PL0582.00.23



Disponível
Saiba mais na página 23

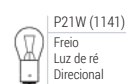

PL9950.17.00

CÓDIGO	DESCRIÇÃO	LENTE	COR	REF. ORIGINAL	EMB.
PL0582.00.01	Lanterna direcional	-	Amarelo	92210025001	10
PL0582.00.02	Lanterna luz de ré	-	Cristal	92210026001	10
PL0582.00.23	Lanterna posição e freio	Acrílica	Vermelho	92210024001	10

REPOSIÇÃO	DESCRIÇÃO	EMB.
PL9900.17.94	Soquete 1 polo universal	10
PL9901.37.94	Soquete 2 polos universal	10
PL9950.17.00	Chicote 2 vias com guarda pó para Faston 6,3mm	10
PL9951.37.00	Chicote 3 vias com guarda pó para Faston 6,3mm	10



PL 0536

Lanterna para implementos aplicação Guerra



SOQUETE LED Disponível
Saiba mais na página 23



CÓDIGO	DESCRIÇÃO	COR	REF. ORIGINAL	EMB.
PL0536.00.01	Lanterna direcional	Amarelo	5001009213001	10
PL0536.00.02	Lanterna luz de ré	Cristal	5001009154009	10
PL0536.00.03	Lanterna posição e freio	Vermelho	5001009211008	10
REPOSIÇÃO	DESCRIÇÃO	EMB.		
PL9900.17.94	Soquete 1 polo universal	10		
PL9901.37.94	Soquete 2 polos universal	10		
PL9950.17.00	Chicote 2 vias com guarda pó para Faston 6,3mm	10		
PL9951.37.00	Chicote 3 vias com guarda pó para Faston 6,3mm	10		

PL 0586

Lanterna com lente lisa para implementos aplicação Guerra



SOQUETE LED Disponível
Saiba mais na página 23



CÓDIGO	DESCRIÇÃO	COR	EMB.
PL0586.00.01	Lanterna direcional	Amarelo	10
PL0586.00.02	Lanterna luz de ré	Cristal	10
PL0586.00.03	Lanterna posição e freio	Vermelho	10
REPOSIÇÃO	DESCRIÇÃO	EMB.	
PL9900.17.94	Soquete 1 polo universal	10	
PL9901.37.94	Soquete 2 polos universal	10	
PL9950.17.00	Chicote 2 vias com guarda pó para Faston 6,3mm	10	
PL9951.37.00	Chicote 3 vias com guarda pó para Faston 6,3mm	10	

PL 0558

Lanterna aplicação Facchini 2ª geração



SOQUETE LED Disponível
Saiba mais na página 23

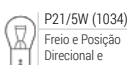

CÓDIGO	DESCRIÇÃO	COR	EMB.
PL0558.00.01	Lanterna direcional	Amarelo	10
PL0558.00.02	Lanterna luz de ré	Cristal	10
PL0558.00.03	Lanterna posição e freio	Vermelho	10
REPOSIÇÃO	DESCRIÇÃO	EMB.	
PL9900.17.94	Soquete 1 polo universal	10	
PL9901.37.94	Soquete 2 polos universal	10	
PL9950.17.00	Chicote 2 vias com guarda pó para Faston 6,3mm	10	
PL9951.37.00	Chicote 3 vias com guarda pó para Faston 6,3mm	10	

PL 0562

Lanterna aplicação Facchini 1ª geração



SOQUETE LED Disponível
Saiba mais na página 23

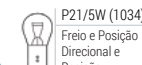
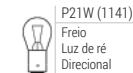

CÓDIGO	DESCRIÇÃO	LENTE	COR	EMB.
PL0562.00.01	Lanterna direcional	-	Amarelo	10
PL0562.00.02	Lanterna luz de ré	-	Cristal	10
PL0562.00.23	Lanterna posição e freio	Acrílica	Vermelho	10
REPOSIÇÃO	DESCRIÇÃO	EMB.		
PL9900.17.94	Soquete 1 polo universal	10		
PL9901.37.94	Soquete 2 polos universal	10		
PL9950.17.00	Chicote 2 vias com guarda pó para Faston 6,3mm	10		
PL9951.37.00	Chicote 3 vias com guarda pó para Faston 6,3mm	10		

PL 0526

Lanterna universal e aplicação em suportes traseiros



SOQUETE LED Disponível
Saiba mais na página 23

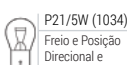
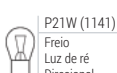

CÓDIGO	DESCRIÇÃO	COR	REF. ORIGINAL	EMB.
PL0526.00.01	Lanterna direcional	Amarelo	210102062	10
PL0526.00.02	Lanterna luz de ré	Cristal	-	10
PL0526.00.03	Lanterna posição e freio	Vermelho	-	10
REPOSIÇÃO	DESCRIÇÃO	EMB.		
PL9900.17.94	Soquete 1 polo universal	10		
PL9901.37.94	Soquete 2 polos universal	10		
PL9950.17.00	Chicote 2 vias com guarda pó para Faston 6,3mm	10		
PL9951.37.00	Chicote 3 vias com guarda pó para Faston 6,3mm	10		

PL 9980

Soquete LED em policarbonato



PL9980.12.61 - 12V
PL9980.24.61 - 24V
PL9980.12.62 - 12V
PL9980.24.62 - 24V
PL9980.12.63 - 12V
PL9980.24.63 - 24V

CÓDIGO	DESCRIÇÃO	TENSÃO	LENTE	COR	EMB.
PL9980.12.61	Soquete LED	LED 12V	Policarbonato	Amarelo	10
PL9980.12.62	Soquete LED	LED 12V	Policarbonato	Cristal	10
PL9980.12.63	Soquete LED	LED 12V	Policarbonato	Vermelho	10
PL9980.24.61	Soquete LED	LED 24V	Policarbonato	Amarelo	10
PL9980.24.62	Soquete LED	LED 24V	Policarbonato	Cristal	10
PL9980.24.63	Soquete LED	LED 24V	Policarbonato	Vermelho	10



PL 0526

Lanterna universal e aplicação em suportes traseiros



CÓDIGO	DESCRIÇÃO	COR	REF. ORIGINAL	EMB.
PL0526.21.01	Lanterna lateral com conector	Amarelo	210102016	10
PL0526.21.02	Lanterna lateral com conector	Cristal	-	10
PL0526.21.03	Lanterna lateral com conector	Vermelho	210102019	10



CÓDIGO	DESCRIÇÃO	TENSÃO	COR	EMB.
PL0526.15.41	Lanterna lateral	LED BIVOLT	Amarelo	10
PL0526.15.42	Lanterna lateral	LED BIVOLT	Cristal	10
PL0526.15.43	Lanterna lateral	LED BIVOLT	Vermelho	10



CÓDIGO	DESCRIÇÃO	TENSÃO	COR	REF. ORIGINAL	EMB.
PL0526.21.41	Lanterna lateral com conector	LED BIVOLT	Amarelo	210102738-P	10
PL0526.21.42	Lanterna lateral com conector	LED BIVOLT	Cristal	-	10
PL0526.21.43	Lanterna lateral com conector	LED BIVOLT	Vermelho	-	10



CÓDIGO	DESCRIÇÃO	COR	EMB.
PL0531.00.01	Lente para lanterna lateral	Amarelo	10
PL0531.00.02	Lente para lanterna lateral	Cristal	10
PL0531.00.03	Lente para lanterna lateral	Vermelho	10
PL9948.17.00	Chicote 2 vias com guarda pó para Faston 6,3mm		10

PL 0312

Lanterna lateral LED com cabos



CÓDIGO	DESCRIÇÃO	TENSÃO	LENTE	COR	EMB.
PL0312.00.61	Lanterna lateral	LED BIVOLT	Acrílica	Amarelo	10
PL0312.00.62	Lanterna lateral	LED BIVOLT	Acrílica	Cristal	10
PL0312.00.63	Lanterna lateral	LED BIVOLT	Acrílica	Vermelho	10
PL0312.00.72	Lanterna lateral	LED BIVOLT	Acrílica	Verde	10

PL 0524

Lanterna lateral universal com haste



CÓDIGO	DESCRIÇÃO	COR	EMB.
PL0524.19.01	Lanterna lateral com conector	Amarelo	10
PL0524.19.02	Lanterna lateral com conector	Cristal	10
PL0524.19.03	Lanterna lateral com conector	Vermelho	10



CÓDIGO	DESCRIÇÃO	TENSÃO	COR	EMB.
PL0524.15.41	Lanterna lateral base reta	LED BIVOLT	Amarelo	10
PL0524.15.42	Lanterna lateral base reta	LED BIVOLT	Cristal	10
PL0524.15.43	Lanterna lateral base reta	LED BIVOLT	Vermelho	10



CÓDIGO	DESCRIÇÃO	TENSÃO	COR	EMB.
PL0524.19.41	Lanterna lateral com conector	LED BIVOLT	Amarelo	10
PL0524.19.42	Lanterna lateral com conector	LED BIVOLT	Cristal	10
PL0524.19.43	Lanterna lateral com conector	LED BIVOLT	Vermelho	10



REPOSIÇÃO	DESCRIÇÃO	EMB.
PL0524.19.17	Haste para lanternas laterais de 85mm - Preta	10
PL9948.17.00	Chicote 2 vias com guarda pó para Faston 6,3mm	10

PL 0412

Lanterna lateral LED com conector



CÓDIGO	DESCRIÇÃO	TENSÃO	LENTE	COR	REF. ORIGINAL	EMB.
PL0412.41.61	Lanterna lateral	LED BIVOLT	Acrílica	Amarelo	-	10
PL0412.41.62	Lanterna lateral	LED BIVOLT	Acrílica	Cristal	210103269	10
PL0412.41.63	Lanterna lateral	LED BIVOLT	Acrílica	Vermelho	-	10
REPOSIÇÃO	DESCRIÇÃO	EMB.				
PL9946.17.00	Chicote com conector ultra seal 2 vias universal	10				
PL9946.41.00	Chicote universal com conector ultra seal 2 vias e conector Faston	10				



PL 0578

Lanterna lateral LED com cabos



LED BIVOLT



PL0578.00.61 PL0578.00.62 PL0578.00.63 PL0578.00.72

CÓDIGO	DESCRIÇÃO	TENSÃO	LENTE	COR	EMB.
PL0578.00.61	Lanterna lateral	LED BIVOLT	Acrílica	Amarelo	10
PL0578.00.62	Lanterna lateral	LED BIVOLT	Acrílica	Cristal	10
PL0578.00.63	Lanterna lateral	LED BIVOLT	Acrílica	Vermelho	10
PL0578.00.72	Lanterna lateral	LED BIVOLT	Acrílica	Verde	10

PL 0584

Lanterna lateral LED com haste e cabos



LED BIVOLT



PL0584.19.61 PL0584.19.62 PL0584.19.63 PL0584.19.72



PL0584.19.17



Vista parte traseira

CÓDIGO	DESCRIÇÃO	TENSÃO	LENTE	COR	EMB.
PL0584.19.61	Lanterna lateral	LED BIVOLT	Acrílica	Amarelo	10
PL0584.19.62	Lanterna lateral	LED BIVOLT	Acrílica	Cristal	10
PL0584.19.63	Lanterna lateral	LED BIVOLT	Acrílica	Vermelho	10
PL0584.19.72	Lanterna lateral	LED BIVOLT	Acrílica	Verde	10
PL0584.19.17	Haste para lanternas laterais de 66mm				10

PL 0690

Lanterna lateral com 2 LEDs blindada



LED BIVOLT



PL0690.00.41 PL0690.00.42 PL0690.00.43 PL0690.00.52



Vista parte traseira

CÓDIGO	DESCRIÇÃO	TENSÃO	COR	EMB.
PL0690.00.41	Lanterna lateral	LED BIVOLT	Amarelo	10
PL0690.00.42	Lanterna lateral	LED BIVOLT	Cristal	10
PL0690.00.43	Lanterna lateral	LED BIVOLT	Vermelho	10
PL0690.00.52	Lanterna lateral	LED BIVOLT	Verde	10

PL 0678

Lanterna lateral LED com conector

LED BIVOLT



PL0678.41.61 PL0678.41.62 PL0678.41.63 PL0678.41.72



Vista parte traseira



PL9946.17.00



PL9946.41.00

CÓDIGO	DESCRIÇÃO	TENSÃO	LENTE	COR	EMB.
PL0678.41.61	Lanterna lateral	LED BIVOLT	Acrílica	Amarelo	10
PL0678.41.62	Lanterna lateral	LED BIVOLT	Acrílica	Cristal	10
PL0678.41.63	Lanterna lateral	LED BIVOLT	Acrílica	Vermelho	10
PL0678.41.72	Lanterna lateral	LED BIVOLT	Acrílica	Verde	10
PL9946.17.00	Chicote com conector ultra seal 2 vias universal				10
PL9946.41.00	Chicote universal com conector ultra seal 2 vias e conector Faston				10

PL 0684

Lanterna lateral LED com haste e conector

LED BIVOLT



PL0684.19.61 PL0684.19.62 PL0684.19.63 PL0684.19.72



Vista parte traseira



PL0584.19.17



PL9946.17.00



PL9946.41.00

CÓDIGO	DESCRIÇÃO	TENSÃO	LENTE	COR	EMB.
PL0684.19.61	Lanterna lateral	LED BIVOLT	Acrílica	Amarelo	10
PL0684.19.62	Lanterna lateral	LED BIVOLT	Acrílica	Cristal	10
PL0684.19.63	Lanterna lateral	LED BIVOLT	Acrílica	Vermelho	10
PL0684.19.72	Lanterna lateral	LED BIVOLT	Acrílica	Verde	10
PL0584.19.17	Haste para lanternas laterais de 66mm				10
PL9946.17.00	Chicote com conector ultra seal 2 vias universal				10
PL9946.41.00	Chicote universal com conector ultra seal 2 vias e conector Faston				10

PL 0688

Lanterna lateral com 2 LEDs e haste acoplada



LED BIVOLT



PL0688.00.41 PL0688.00.42 PL0688.00.43 PL0688.00.52



Vista parte traseira

CÓDIGO	DESCRIÇÃO	TENSÃO	COR	EMB.
PL0688.00.41	Lanterna lateral	LED BIVOLT	Amarelo	10
PL0688.00.42	Lanterna lateral	LED BIVOLT	Cristal	10
PL0688.00.43	Lanterna lateral	LED BIVOLT	Vermelho	10
PL0688.00.52	Lanterna lateral	LED BIVOLT	Verde	10

PL 0638

Lanterna lateral com 2 LEDs e conector



LED BIVOLT



PL0638.41.41



PL0638.41.42



PL0638.41.43



Vista parte traseira



PL9946.17.00



PL9946.41.00

CÓDIGO	DESCRIÇÃO	TENSÃO	COR	EMB.
PL0638.41.41	Lanterna lateral	LED BIVOLT	Amarelo	10
PL0638.41.42	Lanterna lateral	LED BIVOLT	Cristal	10
PL0638.41.43	Lanterna lateral	LED BIVOLT	Vermelho	10
REPOSIÇÃO	DESCRIÇÃO			EMB.
PL9946.17.00	Chicote com conector ultra seal 2 vias universal			10
PL9946.41.00	Chicote universal com conector ultra seal 2 vias e conector Faston			10

PL 0646

Lanterna lateral com 2 LEDs, haste e conector



LED BIVOLT



PL0646.19.41



PL0646.19.42



PL0646.19.43



Vista parte traseira



PL0524.19.17



PL9946.17.00



PL9946.41.00

CÓDIGO	DESCRIÇÃO	TENSÃO	COR	EMB.
PL0646.19.41	Lanterna lateral	LED BIVOLT	Amarelo	10
PL0646.19.42	Lanterna lateral	LED BIVOLT	Cristal	10
PL0646.19.43	Lanterna lateral	LED BIVOLT	Vermelho	10
REPOSIÇÃO	DESCRIÇÃO			EMB.
PL0524.19.17	Haste para lanternas laterais de 85mm - Preta			10
PL9946.17.00	Chicote com conector ultra seal 2 vias universal			10
PL9946.41.00	Chicote universal com conector ultra seal 2 vias e conector Faston			10

PL 0668

Lanterna lateral com 2 LEDs e conector
Aplicação Guerra



LED BIVOLT



PL0668.41.41



PL0668.41.42



PL0668.41.43



Vista parte traseira



PL9946.17.00



PL9946.41.00

CÓDIGO	DESCRIÇÃO	TENSÃO	COR	EMB.
PL0668.41.41	Lanterna lateral	LED BIVOLT	Amarelo	10
PL0668.41.42	Lanterna lateral	LED BIVOLT	Cristal	10
PL0668.41.43	Lanterna lateral	LED BIVOLT	Vermelho	10
REPOSIÇÃO	DESCRIÇÃO			EMB.
PL9946.17.00	Chicote com conector ultra seal 2 vias universal			10
PL9946.41.00	Chicote universal com conector ultra seal 2 vias e conector Faston			10

PL 0686

Lanterna lateral com 2 LEDs, haste e conector
Aplicação Guerra



LED BIVOLT



PL0686.19.41



PL0686.19.42



PL0686.19.43



Vista parte traseira



PL0524.19.17



PL9946.17.00



PL9946.41.00

CÓDIGO	DESCRIÇÃO	TENSÃO	COR	EMB.
PL0686.19.41	Lanterna lateral	LED BIVOLT	Amarelo	10
PL0686.19.42	Lanterna lateral	LED BIVOLT	Cristal	10
PL0686.19.43	Lanterna lateral	LED BIVOLT	Vermelho	10
REPOSIÇÃO	DESCRIÇÃO			EMB.
PL0524.19.17	Haste para lanternas laterais de 85mm - Preta			10
PL9946.17.00	Chicote com conector ultra seal 2 vias universal			10
PL9946.41.00	Chicote universal com conector ultra seal 2 vias e conector Faston			10

PL 0326

Lanterna lateral com lente lisa
Aplicação universal



PL0326.00.01



PL0326.00.02



PL0326.00.03



Vista parte traseira



RSW (67) Posição



PL0326.19.01



PL0326.19.02



PL0326.19.03



Vista parte traseira



RSW (67) Posição



PL0327.00.01



PL0327.00.02



PL0327.00.03



PL0524.19.17

CÓDIGO	DESCRIÇÃO	TENSÃO	COR	EMB.
PL0326.00.01	Lanterna lateral		Amarelo	10
PL0326.00.02	Lanterna lateral		Cristal	10
PL0326.00.03	Lanterna lateral		Vermelho	10
PL0326.19.01	Lanterna lateral com haste		Amarelo	10
PL0326.19.02	Lanterna lateral com haste		Cristal	10
PL0326.19.03	Lanterna lateral com haste		Vermelho	10
REPOSIÇÃO	DESCRIÇÃO		COR	EMB.
PL0327.00.01	Lente lisa para lanterna PL0326		Amarelo	10
PL0327.00.02	Lente lisa para lanterna PL0326		Cristal	10
PL0327.00.03	Lente lisa para lanterna PL0326		Vermelho	10
PL0524.19.17	Haste para lanternas laterais de 88mm		-	10



PL 0564

Lanterna lateral universal
Aplicação Guerra



CÓDIGO	DESCRIÇÃO	COR	REF. ORIGINAL	EMB.
PL0564.00.01	Lanterna lateral com conector	Amarelo	5001009216007 ou 3992	10
PL0564.00.02	Lanterna lateral com conector	Cristal	-	10
PL0564.00.03	Lanterna lateral com conector	Vermelho	5001009219002 ou 3993	10

LED BIVOLT

CÓDIGO	DESCRIÇÃO	TENSÃO	COR	EMB.
PL0564.15.41	Lanterna lateral base reta	LED BIVOLT	Amarelo	10
PL0564.15.42	Lanterna lateral base reta	LED BIVOLT	Cristal	10
PL0564.15.43	Lanterna lateral base reta	LED BIVOLT	Vermelho	10

LED BIVOLT

CÓDIGO	DESCRIÇÃO	TENSÃO	COR	EMB.
PL0564.00.41	Lanterna lateral com conector	LED BIVOLT	Amarelo	10
PL0564.00.42	Lanterna lateral com conector	LED BIVOLT	Cristal	10
PL0564.00.43	Lanterna lateral com conector	LED BIVOLT	Vermelho	10

CÓDIGO	DESCRIÇÃO	COR	EMB.
PL0565.00.01	Lente para lanterna lateral	Amarelo	10
PL0565.00.02	Lente para lanterna lateral	Cristal	10
PL0565.00.03	Lente para lanterna lateral	Vermelho	10
PL9948.17.00	Chicote 2 vias com guarda pó para Faston 6,3mm		10

PL 0616

Lanterna direcional
Viraje amplo / Giro amplo



PL0616.01.13 - LD
PL0616.02.13 - LE



PL0617.01.13 - LD
PL0617.02.13 - LE

P21W (1141) Direcional

CÓDIGO	DESCRIÇÃO	LADO	COR	EMB.
PL0616.01.13	Viraje amplo	Direito	Amarelo	08
PL0616.02.13	Viraje amplo	Esquerdo	Amarelo	08
REPOSIÇÃO	DESCRIÇÃO	LADO	COR	EMB.
PL0617.01.13	Lente viraje amplo	Direito	Amarelo	10
PL0617.02.13	Lente viraje amplo	Esquerdo	Amarelo	10

PL 0566

Lanterna lateral universal com haste
Aplicação Guerra



CÓDIGO	DESCRIÇÃO	COR	REF. ORIGINAL	EMB.
PL0566.19.01	Lanterna lateral com conector	Amarelo	4059	10
PL0566.19.02	Lanterna lateral com conector	Cristal	-	10
PL0566.19.03	Lanterna lateral com conector	Vermelho	-	10

LED BIVOLT

CÓDIGO	DESCRIÇÃO	TENSÃO	COR	EMB.
PL0566.15.41	Lanterna lateral base reta	LED BIVOLT	Amarelo	10
PL0566.15.42	Lanterna lateral base reta	LED BIVOLT	Cristal	10
PL0566.15.43	Lanterna lateral base reta	LED BIVOLT	Vermelho	10

LED BIVOLT

CÓDIGO	DESCRIÇÃO	TENSÃO	COR	EMB.
PL0566.19.41	Lanterna lateral com conector	LED BIVOLT	Amarelo	10
PL0566.19.42	Lanterna lateral com conector	LED BIVOLT	Cristal	10
PL0566.19.43	Lanterna lateral com conector	LED BIVOLT	Vermelho	10

REPOSIÇÃO	DESCRIÇÃO	EMB.
PL0524.19.17	Haste para lanternas laterais de 85mm	10
PL9948.17.00	Chicote 2 vias com guarda pó para Faston 6,3mm	10



PL 0606

Lanterna lateral refletiva
Aplicação Facchini



PL0606.41.01



PL0606.41.02



PL0606.41.03



Vista parte traseira



W5W
Posição

CÓDIGO	DESCRIÇÃO	COR	EMB.
PL0606.41.01	Lanterna lateral com conector	Amarelo	10
PL0606.41.02	Lanterna lateral com conector	Cristal	10
PL0606.41.03	Lanterna lateral com conector	Vermelho	10



PL0606.19.01



PL0606.19.02



PL0606.19.03



Vista parte traseira



W5W
Posição

CÓDIGO	DESCRIÇÃO	COR	EMB.
PL0606.19.01	Lanterna lateral com haste e conector	Amarelo	10
PL0606.19.02	Lanterna lateral com haste e conector	Cristal	10
PL0606.19.03	Lanterna lateral com haste e conector	Vermelho	10



PL0606.41.41



PL0606.41.42



PL0606.41.43



Vista parte traseira

CÓDIGO	DESCRIÇÃO	TENSÃO	COR	EMB.
PL0606.41.41	Lanterna lateral com conector	LED BIVOLT	Amarelo	10
PL0606.41.42	Lanterna lateral com conector	LED BIVOLT	Cristal	10
PL0606.41.43	Lanterna lateral com conector	LED BIVOLT	Vermelho	10



PL0606.19.41



PL0606.19.42



PL0606.19.43



Vista parte traseira

CÓDIGO	DESCRIÇÃO	TENSÃO	COR	EMB.
PL0606.19.41	Lanterna lateral com haste e conector	LED BIVOLT	Amarelo	10
PL0606.19.42	Lanterna lateral com haste e conector	LED BIVOLT	Cristal	10
PL0606.19.43	Lanterna lateral com haste e conector	LED BIVOLT	Vermelho	10



PL0606.15.41



PL0606.15.42



PL0606.15.43



Vista parte traseira

CÓDIGO	DESCRIÇÃO	TENSÃO	COR	EMB.
PL0606.15.41	Lanterna lateral base reta	LED BIVOLT	Amarelo	10
PL0606.15.42	Lanterna lateral base reta	LED BIVOLT	Cristal	10
PL0606.15.43	Lanterna lateral base reta	LED BIVOLT	Vermelho	10



PL0606.30.41



PL0606.30.42



PL0606.30.43



Vista parte traseira

CÓDIGO	DESCRIÇÃO	TENSÃO	COR	EMB.
PL0606.30.41	Lanterna lateral com haste e base reta	LED BIVOLT	Amarelo	10
PL0606.30.42	Lanterna lateral com haste e base reta	LED BIVOLT	Cristal	10
PL0606.30.43	Lanterna lateral com haste e base reta	LED BIVOLT	Vermelho	10

Para lâmpada tipo torpeda



PL0606.21.01



PL0606.21.02



Vista parte traseira



C5W
Interno

CÓDIGO	DESCRIÇÃO	COR	EMB.
PL0606.21.01	Lanterna lateral para lâmpada tipo torpeda	Amarelo	10
PL0606.21.02	Lanterna lateral para lâmpada tipo torpeda	Cristal	10

Para lâmpada tipo torpeda



PL0606.22.01



PL0606.22.02



Vista parte traseira



C5W
Interno

CÓDIGO	DESCRIÇÃO	COR	EMB.
PL0606.22.01	Lanterna lateral com haste para lâmpada tipo torpeda	Amarelo	10
PL0606.22.02	Lanterna lateral com haste para lâmpada tipo torpeda	Cristal	10



PL0607.00.01



PL0607.00.02



PL0607.00.03

REPOSIÇÃO	DESCRIÇÃO	COR	EMB.
PL0607.00.01	Lente refletiva para lanterna PL0606	Amarelo	20
PL0607.00.02	Lente refletiva para lanterna PL0606	Cristal	20
PL0607.00.03	Lente refletiva para lanterna PL0606	Vermelho	20



PL0606.19.17



PL9948.17.00

REPOSIÇÃO	DESCRIÇÃO	EMB.
PL0606.19.17	Haste para lanternas tipo Facchini e universal - Preta	10
PL9948.17.00	Chicote 2 vias com guarda pó para Faston 6,3mm	10

PL 0608

Lanterna lateral com refletivo
Aplicação Facchini e universal



PL0608.19.41



PL0608.19.42



PL0608.19.43



PL0608.19.52

Vista parte traseira

CÓDIGO	DESCRIÇÃO	TENSÃO	COR	EMB.
PL0608.19.41	Lanterna lateral com haste e base reta	LED BIVOLT	Amarelo	10
PL0608.19.42	Lanterna lateral com haste e base reta	LED BIVOLT	Cristal	10
PL0608.19.43	Lanterna lateral com haste e base reta	LED BIVOLT	Vermelho	10
PL0608.19.52	Lanterna lateral com haste e base reta	LED BIVOLT	Verde	10



PL0608.00.41



PL0608.00.42



PL0608.00.43



PL0608.00.52

Vista parte traseira

CÓDIGO	DESCRIÇÃO	TENSÃO	COR	EMB.
PL0608.00.41	Lanterna lateral base reta	LED BIVOLT	Amarelo	10
PL0608.00.42	Lanterna lateral base reta	LED BIVOLT	Cristal	10
PL0608.00.43	Lanterna lateral base reta	LED BIVOLT	Vermelho	10
PL0608.00.52	Lanterna lateral base reta	LED BIVOLT	Verde	10



PL 0640

Lanterna lateral SLIM com guia de luz LED
Aplicação Universal



CÓDIGO	DESCRIÇÃO	TENSÃO	LENTE	COR	EMB.
PL0640.00.61	Com cabos para conexão	LED BIVOLT	Acrílico	Amarelo	10
PL0640.00.62	Com cabos para conexão	LED BIVOLT	Acrílico	Cristal	10
PL0640.00.63	Com cabos para conexão	LED BIVOLT	Acrílico	Vermelho	10
PL0640.00.66	Com cabos para conexão	LED BIVOLT	Acrílico	Cristal e amarelo	10



PL0640.41.61



PL0640.41.62



PL0640.41.63



PL0640.41.66



PL9946.17.00



PL9946.41.00

CÓDIGO	DESCRIÇÃO	TENSÃO	LENTE	COR	EMB.
PL0640.41.61	Com conector	LED BIVOLT	Acrílico	Amarelo	10
PL0640.41.62	Com conector	LED BIVOLT	Acrílico	Cristal	10
PL0640.41.63	Com conector	LED BIVOLT	Acrílico	Vermelho	10
PL0640.41.66	Com conector	LED BIVOLT	Acrílico	Cristal e amarelo	10
REPOSIÇÃO	DESCRIÇÃO				EMB.
PL9946.17.00	Chicote com conector ultra seal 2 vias universal				10
PL9946.41.00	Chicote universal com conector ultra seal 2 vias e conector Faston				10

PL 0642

Lanterna lateral SLIM com guia de luz LED e suporte
Aplicação Universal



CÓDIGO	DESCRIÇÃO	TENSÃO	LENTE	COR	EMB.
PL0642.00.61	Com suporte e cabos	LED BIVOLT	Acrílico	Amarelo	10
PL0642.00.62	Com suporte e cabos	LED BIVOLT	Acrílico	Cristal	10
PL0642.00.63	Com suporte e cabos	LED BIVOLT	Acrílico	Vermelho	10
PL0642.00.66	Com suporte e cabos	LED BIVOLT	Acrílico	Cristal e amarelo	10



Vista parte traseira



PL0642.41.61



PL0642.41.62



PL0642.41.63



Vista parte traseira



PL0642.41.66

CÓDIGO	DESCRIÇÃO	TENSÃO	LENTE	COR	EMB.
PL0642.41.61	Com suporte e conector	LED BIVOLT	Acrílico	Amarelo	10
PL0642.41.62	Com suporte e conector	LED BIVOLT	Acrílico	Cristal	10
PL0642.41.63	Com suporte e conector	LED BIVOLT	Acrílico	Vermelho	10
PL0642.41.66	Com suporte e conector	LED BIVOLT	Acrílico	Cristal e amarelo	10

Informações técnicas



Vista traseira



Com 2 Led's e guia de Luz





PL 0902

Lanterna universal tipo Mercosul



PL0902.00.21



PL0902.00.22



PL0902.00.23



PL0902.00.32

CÓDIGO	DESCRIÇÃO	LENTE	COR	EMB.
PL0902.00.21	Para lâmpada R5W	Acrílica	Amarelo	10
PL0902.00.22	Para lâmpada R5W	Acrílica	Cristal	10
PL0902.00.23	Para lâmpada R5W	Acrílica	Vermelho	10
PL0902.00.32	Para lâmpada R5W	Acrílica	Verde	10



PL0902.51.21



PL0902.51.22



PL0902.51.23



PL0902.51.32

CÓDIGO	DESCRIÇÃO	LENTE	COR	EMB.
PL0902.51.21	Para lâmpada R5W e haste PVC	Acrílica	Amarelo	10
PL0902.51.22	Para lâmpada R5W e haste PVC	Acrílica	Cristal	10
PL0902.51.23	Para lâmpada R5W e haste PVC	Acrílica	Vermelho	10
PL0902.51.32	Para lâmpada R5W e haste PVC	Acrílica	Verde	10



PL0902.21.21



PL0902.21.22



PL0902.21.23



PL0902.21.32

CÓDIGO	DESCRIÇÃO	LENTE	COR	EMB.
PL0902.21.21	Para lâmpada esmagada	Acrílica	Amarelo	10
PL0902.21.22	Para lâmpada esmagada	Acrílica	Cristal	10
PL0902.21.23	Para lâmpada esmagada	Acrílica	Vermelho	10
PL0902.21.32	Para lâmpada esmagada	Acrílica	Verde	10



PL0902.46.21



PL0902.46.22



PL0902.46.23



PL0902.46.32

CÓDIGO	DESCRIÇÃO	LENTE	COR	EMB.
PL0902.46.21	Para lâmpada esmagada e haste PVC	Acrílica	Amarelo	10
PL0902.46.22	Para lâmpada esmagada e haste PVC	Acrílica	Cristal	10
PL0902.46.23	Para lâmpada esmagada e haste PVC	Acrílica	Vermelho	10
PL0902.46.32	Para lâmpada esmagada e haste PVC	Acrílica	Verde	10



PL0902.00.61



PL0902.00.62

LED BIVOLT



PL0902.00.63



PL0902.00.72

CÓDIGO	DESCRIÇÃO	TENSÃO	LENTE	COR	EMB.
PL0902.00.61	Com LED	LED BIVOLT	Acrílica	Amarelo	10
PL0902.00.62	Com LED	LED BIVOLT	Acrílica	Cristal	10
PL0902.00.63	Com LED	LED BIVOLT	Acrílica	Vermelho	10
PL0902.00.72	Com LED	LED BIVOLT	Acrílica	Verde	10



PL0902.46.61



PL0902.46.62

LED BIVOLT



PL0902.46.63



PL0902.46.72

CÓDIGO	DESCRIÇÃO	TENSÃO	LENTE	COR	EMB.
PL0902.46.61	Com LED e haste PVC	LED BIVOLT	Acrílica	Amarelo	10
PL0902.46.62	Com LED e haste PVC	LED BIVOLT	Acrílica	Cristal	10
PL0902.46.63	Com LED e haste PVC	LED BIVOLT	Acrílica	Vermelho	10
PL0902.46.72	Com LED e haste PVC	LED BIVOLT	Acrílica	Verde	10



PL0903.00.21



PL0903.00.22



PL0903.00.23



PL0903.00.32

CÓDIGO	DESCRIÇÃO	LENTE	COR	EMB.
PL0903.00.21	Lente para lanterna PL0902	Acrílica	Amarelo	10
PL0903.00.22	Lente para lanterna PL0902	Acrílica	Cristal	10
PL0903.00.23	Lente para lanterna PL0902	Acrílica	Vermelho	10
PL0903.00.32	Lente para lanterna PL0902	Acrílica	Verde	10



PL 0904

Lanterna universal tipo Mercosul

LED BIVOLT



PL0904.00.21



PL0904.00.22



PL0904.00.61



PL0904.00.62



PL0904.00.23



PL0904.00.32



PL0904.00.63



PL0904.00.72



CÓDIGO	DESCRIÇÃO	LENTE	COR	EMB.
PL0904.00.21	Para lâmpada esmagada	Acrílica	Amarelo	10
PL0904.00.22	Para lâmpada esmagada	Acrílica	Cristal	10
PL0904.00.23	Para lâmpada esmagada	Acrílica	Vermelho	10
PL0904.00.32	Para lâmpada esmagada	Acrílica	Verde	10

CÓDIGO	DESCRIÇÃO	TENSÃO	LENTE	COR	EMB.
PL0904.00.61	Com LED	LED BIVOLT	Acrílica	Amarelo	10
PL0904.00.62	Com LED	LED BIVOLT	Acrílica	Cristal	10
PL0904.00.63	Com LED	LED BIVOLT	Acrílica	Vermelho	10
PL0904.00.72	Com LED	LED BIVOLT	Acrílica	Verde	10



PL0904.19.21



PL0904.19.22



PL0904.19.61



PL0904.19.62



PL0904.19.23



PL0904.19.32



CÓDIGO	DESCRIÇÃO	LENTE	COR	EMB.
PL0904.19.21	Com haste para lâmpada esmagada	Acrílica	Amarelo	10
PL0904.19.22	Com haste para lâmpada esmagada	Acrílica	Cristal	10
PL0904.19.23	Com haste para lâmpada esmagada	Acrílica	Vermelho	10
PL0904.19.32	Com haste para lâmpada esmagada	Acrílica	Verde	10

CÓDIGO	DESCRIÇÃO	TENSÃO	LENTE	COR	EMB.
PL0904.19.61	Com LED e haste	LED BIVOLT	Acrílica	Amarelo	10
PL0904.19.62	Com LED e haste	LED BIVOLT	Acrílica	Cristal	10
PL0904.19.63	Com LED e haste	LED BIVOLT	Acrílica	Vermelho	10
PL0904.19.72	Com LED e haste	LED BIVOLT	Acrílica	Verde	10



PL0904.46.21



PL0904.46.22



PL0904.46.61



PL0904.46.62



PL0904.46.23



PL0904.46.32



CÓDIGO	DESCRIÇÃO	LENTE	COR	EMB.
PL0904.46.21	Com haste PVC para lâmpada esmagada	Acrílica	Amarelo	10
PL0904.46.22	Com haste PVC para lâmpada esmagada	Acrílica	Cristal	10
PL0904.46.23	Com haste PVC para lâmpada esmagada	Acrílica	Vermelho	10
PL0904.46.32	Com haste PVC para lâmpada esmagada	Acrílica	Verde	10

CÓDIGO	DESCRIÇÃO	TENSÃO	LENTE	COR	EMB.
PL0904.46.61	Com LED e haste PVC	LED BIVOLT	Acrílica	Amarelo	10
PL0904.46.62	Com LED e haste PVC	LED BIVOLT	Acrílica	Cristal	10
PL0904.46.63	Com LED e haste PVC	LED BIVOLT	Acrílica	Vermelho	10
PL0904.46.72	Com LED e haste PVC	LED BIVOLT	Acrílica	Verde	10



PL0905.00.21



PL0905.00.22



PL0905.00.23



PL0905.00.32

REPOSIÇÃO	DESCRIÇÃO	LENTE	COR	EMB.
PL0905.00.21	Lente para lanterna PL0904	Acrílica	Amarelo	10
PL0905.00.22	Lente para lanterna PL0904	Acrílica	Cristal	10
PL0905.00.23	Lente para lanterna PL0904	Acrílica	Vermelho	10
PL0905.00.32	Lente para lanterna PL0904	Acrílica	Verde	10



PL0905.21.21



PL0905.21.22



PL0905.21.23



PL0905.21.32

REPOSIÇÃO	DESCRIÇÃO	LENTE	COR	EMB.
PL0905.21.21	Lente para lanterna PL0904 LED	Acrílica	Amarelo	10
PL0905.21.22	Lente para lanterna PL0904 LED	Acrílica	Cristal	10
PL0905.21.23	Lente para lanterna PL0904 LED	Acrílica	Vermelho	10
PL0905.21.32	Lente para lanterna PL0904 LED	Acrílica	Verde	10



PL 0544

Lanterna luz de placa



PL0544.00.17



CÓDIGO	DESCRIÇÃO	COR	EMB.
PL0544.00.17	Lanterna luz de placa	Cristal	15



PL0544.00.57



CÓDIGO	DESCRIÇÃO	TENSÃO	COR	EMB.
PL0544.00.57	Lanterna luz de placa com 2 LEDs	LED BIVOLT	Cristal	15

PL 0480

Lanterna luz de placa universal



PL0480.00.56



PL0480.00.16



PL0481.00.16



CÓDIGO	DESCRIÇÃO	TENSÃO	COR	EMB.
PL0480.00.56	Lanterna luz de placa com 2 LEDs	LED BIVOLT	Alumínio	10
PL0480.00.16	Lanterna luz de placa	-	Alumínio	10
PL0481.00.16	Lente para lanterna PL0480	-	Alumínio	10



PL0480.00.41



PL0480.00.42



PL0480.00.43

CÓDIGO	DESCRIÇÃO	TENSÃO	COR	EMB.
PL0480.00.41	Lanterna luz de placa com 1 LED	LED BIVOLT	Amarelo	10
PL0480.00.42	Lanterna luz de placa com 1 LED	LED BIVOLT	Cristal	10
PL0480.00.43	Lanterna luz de placa com 1 LED	LED BIVOLT	Vermelho	10



PL0480.00.01



PL0480.00.02



PL0480.00.03



CÓDIGO	DESCRIÇÃO	COR	EMB.
PL0480.00.01	Lanterna luz de placa	Amarelo	10
PL0480.00.02	Lanterna luz de placa	Cristal	10
PL0480.00.03	Lanterna luz de placa	Vermelho	10



PL0481.00.01



PL0481.00.02



PL0481.00.03

CÓDIGO	DESCRIÇÃO	COR	EMB.
PL0481.00.01	Lente para lanterna PL0480	Amarelo	10
PL0481.00.02	Lente para lanterna PL0480	Cristal	10
PL0481.00.03	Lente para lanterna PL0480	Vermelho	10

PL 1322

Lanterna LED delimitadora e luz de placa
Aplicação ônibus Neobus e Induscar



PL1322.00.62



PL1322.00.61



PL1322.00.63

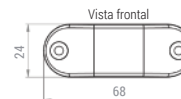

Vista frontal

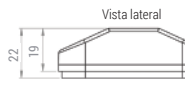

Vista lateral

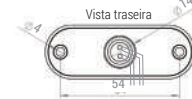

Vista traseira

CÓDIGO	DESCRIÇÃO	TENSÃO	LENTE	COR	EMB.
PL1322.00.62	Com 2 LEDs	LED BIVOLT	Acrílica	Cristal	10
PL1322.00.61	Com 2 LEDs	LED BIVOLT	Acrílica	Amarelo	10
PL1322.00.63	Com 2 LEDs	LED BIVOLT	Acrílica	Vermelho	10



PL1322.41.62



PL1322.41.61



PL1322.41.63

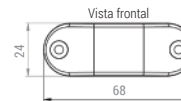

Vista frontal

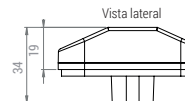

Vista lateral



Vista traseira

CÓDIGO	DESCRIÇÃO	TENSÃO	LENTE	COR	EMB.
PL1322.41.62	Com 2 LEDs e conector	LED BIVOLT	Acrílica	Cristal	10
PL1322.41.61	Com 2 LEDs e conector	LED BIVOLT	Acrílica	Amarelo	10
PL1322.41.63	Com 2 LEDs e conector	LED BIVOLT	Acrílica	Vermelho	10

PL 1334

Lanterna LED delimitadora e luz de placa



PL1334.00.62



PL1334.00.61



Vista frontal



PL1334.00.63

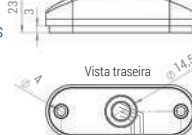

Vista lateral

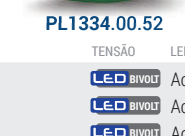

PL1334.00.52

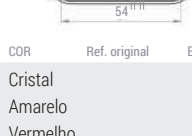

Vista traseira

CÓDIGO	DESCRIÇÃO	TENSÃO	LENTE	COR	Ref. original	EMB.
PL1334.00.62	Com 2 LEDs	LED BIVOLT	Acrílica	Cristal		10
PL1334.00.61	Com 2 LEDs	LED BIVOLT	Acrílica	Amarelo		10
PL1334.00.63	Com 2 LEDs	LED BIVOLT	Acrílica	Vermelho		10
PL1334.00.52	Lanterna para freio ABS de carretas com 2 LEDs	LED BIVOLT	Acrílica	Verde	4461055232	10



PL1334.41.62



PL1334.41.61

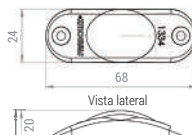

Vista frontal



PL1334.41.63

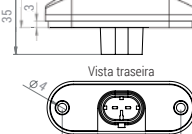

Vista lateral

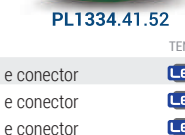

PL1334.41.52



Vista traseira

CÓDIGO	DESCRIÇÃO	TENSÃO	LENTE	COR	EMB.
PL1334.41.62	Com 2 LEDs e conector	LED BIVOLT	Acrílica	Cristal	10
PL1334.41.61	Com 2 LEDs e conector	LED BIVOLT	Acrílica	Amarelo	10
PL1334.41.63	Com 2 LEDs e conector	LED BIVOLT	Acrílica	Vermelho	10
PL1334.41.52	Lanterna para freio ABS de carretas com 2 LEDs e conector	LED BIVOLT	Acrílica	Verde	10



FORD CARGO 2422



PL7016



PL0462

Soquete disponível

PL9913



PL0434

Soquete disponível

PL9936



PL0426

Soquete disponível

PL9913



PL0440

PL 7010

Farol duplo horizontal com soquete amarelo
Aplicação caminhões Ford Cargo 2000 a 2006



PL7010.01.22 - LD
PL7010.02.22 - LE



Vista parte traseira



PL7011.00.22



PL7013.00.22



H7
Farol

Não acompanha lâmpada

CÓDIGO	DESCRIÇÃO	LADO	COR	REF. ORIGINAL	EMB.
PL7010.01.22	Farol duplo	Direito	Cristal	1C45-13005-SCA	01
PL7010.02.22	Farol duplo	Esquerdo	Cristal	1C45-13006-SCA	01

CÓDIGO	DESCRIÇÃO	COR	EMB.
PL7011.00.22	Módulo óptico Farol luz alta Cargo 2000 a 2006	Cristal	01
PL7013.00.22	Módulo óptico Farol luz baixa Cargo 2000 a 2006	Cristal	01

PL 7012

Farol duplo diagonal com soquete amarelo
Aplicação caminhões Ford Cargo 2000 a 2006



PL7012.01.22 - LD
PL7012.02.22 - LE



Vista parte traseira



PL7011.00.22

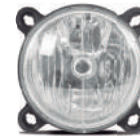

PL7013.00.22



H7
Farol

Não acompanha lâmpada

CÓDIGO	DESCRIÇÃO	LADO	COR	REF. ORIGINAL	EMB.
PL7012.01.22	Farol duplo	Direito	Cristal	1C45-13005-SBA	01
PL7012.02.22	Farol duplo	Esquerdo	Cristal	1C45-13006-SBA	01

CÓDIGO	DESCRIÇÃO	COR	EMB.
PL7011.00.22	Módulo óptico Farol luz alta Cargo 2000 a 2006	Cristal	01
PL7013.00.22	Módulo óptico Farol luz baixa Cargo 2000 a 2006	Cristal	01

PL 7014

Farol duplo horizontal com soquete azul
Aplicação caminhões Ford Cargo 2006 a 2012

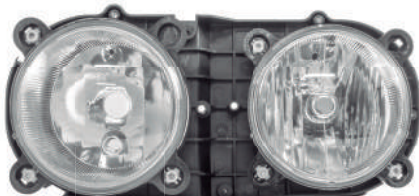

PL7014.01.22 - LD
PL7014.02.22 - LE



Vista parte traseira



PL7007.00.22



PL7009.00.22



H7
Farol

Não acompanha lâmpada

CÓDIGO	DESCRIÇÃO	LADO	COR	EMB.
PL7014.01.22	Farol duplo	Direito	Cristal	01
PL7014.02.22	Farol duplo	Esquerdo	Cristal	01

CÓDIGO	DESCRIÇÃO	COR	EMB.
PL7007.00.22	Módulo óptico Farol luz alta Cargo a partir de 2006	Cristal	01
PL7009.00.22	Módulo óptico Farol luz baixa Cargo a partir de 2006	Cristal	01

PL 7016

Farol duplo diagonal com soquete azul
Aplicação caminhões Ford Cargo 2006 a 2012



PL7016.01.22 - LD
PL7016.02.22 - LE



Vista parte traseira



PL7007.00.22



PL7009.00.22



H7
Farol

Não acompanha lâmpada

CÓDIGO	DESCRIÇÃO	LADO	COR	EMB.
PL7016.01.22	Farol duplo	Direito	Cristal	01
PL7016.02.22	Farol duplo	Esquerdo	Cristal	01

CÓDIGO	DESCRIÇÃO	COR	EMB.
PL7007.00.22	Módulo óptico Farol luz alta Cargo a partir de 2006	Cristal	01
PL7009.00.22	Módulo óptico Farol luz baixa Cargo a partir de 2006	Cristal	01



FORD CARGO 2429



PL7006



PL7008



PL0462 PL9913

Soquete disponível



PL0496



PL9934

Soquete disponível



PL0474

Chicote disponível

PL9995



PL0716



PL9999

Chicote disponível

PL 7006

Farol principal de luz alta
Aplicação caminhões Ford Cargo a partir de 2012



PL7006.01.22 - LD
PL7006.02.22 - LE



Vista parte traseira



PL7007.00.22



PL7008.01.22 - LD
PL7008.02.22 - LE



Vista parte traseira



PL7009.00.22

Não acompanha lâmpada

CÓDIGO	DESCRIÇÃO	LADO	COR	REF. ORIGINAL	EMB.
PL7006.01.22	Farol principal de luz alta	Direito	Cristal	BC4513D118AC	01
PL7006.02.22	Farol principal de luz alta	Esquerdo	Cristal	BC4513D119AC	01

CÓDIGO	DESCRIÇÃO	COR	EMB.
PL7007.00.22	Módulo óptico Farol luz alta Cargo a partir de 2006	Cristal	01



H7 Farol

Não acompanha lâmpada

CÓDIGO	DESCRIÇÃO	LADO	COR	REF. ORIGINAL	EMB.
PL7008.01.22	Farol luz baixa	Direito	Cristal	BC4513D268AE	01
PL7008.02.22	Farol luz baixa	Esquerdo	Cristal	BC4513D269AE	01

CÓDIGO	DESCRIÇÃO	COR	EMB.
PL7009.00.22	Módulo óptico Farol luz baixa Cargo a partir de 2006	Cristal	01



H7 Farol

PL 7023

Módulo óptico para farol principal
Aplicação caminhões Ford Cargo 815 / 1119 de 2014 até 2019



PL7023.01.22 - LD
PL7023.02.22 - LE



Vista parte traseira

Não acompanha lâmpada

CÓDIGO	DESCRIÇÃO	LADO	COR	REF. ORIGINAL	EMB.
PL7023.01.22	Módulo óptico	Direito	Cristal	EC45 13005	01
PL7023.02.22	Módulo óptico	Esquerdo	Cristal	EC45 13006	01



H4 Farol

PL 0464

Lanterna direcional
Aplicação Ford Cargo 1720 e outros



PL0464.00.01



PL0464.00.02



PL0464.00.13

CÓDIGO	DESCRIÇÃO	COR	REF. ORIGINAL	EMB.
PL0464.00.01	Lanterna direcional	Amarelo	90HU13368B	04
PL0464.00.02	Lanterna direcional	Cristal	-	04
PL0464.00.13	Lanterna direcional	Amarelo fosca	-	04



R5W (67) Posição



FORD CARGO 815

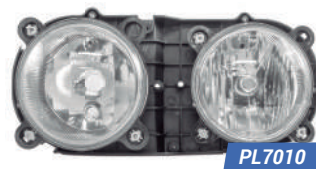

PL 0434

Lanterna direcional
Aplicação Ford Cargo



PL0434.23.02 - LD **PL0434.23.22** - Lente acrílica LD
PL0434.24.02 - LE **PL0434.24.22** - Lente acrílica LE

CÓDIGO	DESCRIÇÃO	LENTE	LADO	COR	EMB.
PL0434.23.02	Lente lisa	-	Direito	Cristal	10
PL0434.24.02	Lente lisa	-	Esquerdo	Cristal	10
PL0434.23.22	Lente lisa	Acrílica	Direito	Cristal	10
PL0434.24.22	Lente lisa	Acrílica	Esquerdo	Cristal	10
REPOSIÇÃO	DESCRIÇÃO			REF. ORIGINAL	EMB.
PL9936.17.94	Chicote com soquete 1 polo tipo cachimbo e terminal			TJG972383	10



PL0434.03.02 - LD
PL0434.04.02 - LE

CÓDIGO	DESCRIÇÃO	LADO	COR	REF. ORIGINAL	EMB.
PL0434.03.02	Com cúpula	Direito	Cristal	2UH953042	10
PL0434.04.02	Com cúpula	Esquerdo	Cristal	2UH953041	10
REPOSIÇÃO	DESCRIÇÃO			REF. ORIGINAL	EMB.
PL9936.17.94	Chicote com soquete 1 polo tipo cachimbo e terminal			TJG972383	10



PL0434.01.01 - LD
PL0434.02.01 - LE

CÓDIGO	LADO	COR	REF. ORIGINAL	EMB.
PL0434.01.01	Direito	Amarelo	86HU13369AA	10
PL0434.02.01	Esquerdo	Amarelo	86HU13368AA	10
REPOSIÇÃO	DESCRIÇÃO		REF. ORIGINAL	EMB.
PL9936.17.94	Chicote com soquete 1 polo tipo cachimbo e terminal		TJG972383	10

PL 0460

Lanterna direcional
Aplicação caminhões Ford



CÓDIGO	DESCRIÇÃO	LADO	COR	REF. ORIGINAL	EMB.
PL0460.01.02	Aplicação Arteb	Direito	Cristal	7295 3046 D	04
PL0460.02.02	Aplicação Arteb	Esquerdo	Cristal	7295 3045 E	04
PL0460.21.02	Aplicação Cibie	Direito	Cristal	-	04
PL0460.22.02	Aplicação Cibie	Esquerdo	Cristal	-	04

PL 0474

Lanterna direcional e delimitadora
Aplicação Ford Cargo (2012 em diante)



PL0474.01.21 - LD
PL0474.02.21 - LE

PL0474.33.41 - LD
PL0474.34.41 - LE



CÓDIGO	LADO	COR	TENSÃO	REF. ORIGINAL	EMB.
PL0474.01.21	Direito	Amarelo	-	AC46/ 13B376/AB/	02
PL0474.02.21	Esquerdo	Amarelo	-	AC46/ 13B377/AB/	02
PL0474.33.41	Direito	Amarelo	LED24V	-	02
PL0474.34.41	Esquerdo	Amarelo	LED24V	-	02
REPOSIÇÃO	DESCRIÇÃO				EMB.
PL9995.37.97	Chicote com conector 3 vias				10



PL 0494

Lanterna direcional
Aplicação Ford Cargo traçado frente horizontal



PL0494.00.22



PL0494.41.22



Vista lateral



PL9934.17.95



PY21W (1056)
Direcional

CÓDIGO	DESCRIÇÃO	LENTE	COR	REF. ORIGINAL	EMB.
PL0494.00.22	Sem soquete	Policarbonato	Cristal	-	06
PL0494.41.22	Com soquete	Policarbonato	Cristal	4C46/13368/CA	06
REPOSIÇÃO	DESCRIÇÃO				EMB.
PL9934.17.95	Soquete com 1 polo em nylon tipo Ford				10

PL 0496

Lanterna direcional
Aplicação Ford Cargo frente diagonal



PL0496.00.22



PL0496.41.22



Vista lateral



PL9934.17.95



PY21W (1056)
Direcional

CÓDIGO	DESCRIÇÃO	LENTE	COR	REF. ORIGINAL	EMB.
PL0496.00.22	Sem soquete	Policarbonato	Cristal	-	06
PL0496.41.22	Com soquete	Policarbonato	Cristal	4C46/13368/BA	06
REPOSIÇÃO	DESCRIÇÃO				EMB.
PL9934.17.95	Soquete com 1 polo em nylon tipo Ford				10

PL 1314

Lanterna direcional e delimitadora
Aplicação Ford 1119 e 816 e ônibus



PL1314.00.21



Vista parte lateral



SOQUETE LED Disponível
Saiba mais na página 23



P21W (1141)
Direcional



P21/5W (1034)
Direcional e Posição

CÓDIGO	DESCRIÇÃO	LENTE	COR	REF. ORIGINAL	EMB.
PL9900.17.94					
PL9901.37.94					
PL9950.17.00					
PL9951.37.00					
CÓDIGO	DESCRIÇÃO	LENTE	COR	REF. ORIGINAL	EMB.
PL1314.00.21	Sem soquete	Acrílico	Amarelo	EC45 13B376 AD (Direito) EC45 13B377 AD (Esquerdo)	10
REPOSIÇÃO	DESCRIÇÃO				EMB.
PL9900.17.94	Soquete 1 polo universal				10
PL9901.37.94	Soquete 2 polos universal				10
PL9950.17.00	Chicote 2 vias com guarda pó para Faston 6,3mm				10
PL9951.37.00	Chicote 3 vias com guarda pó para Faston 6,3mm				10

PL 0426

Lanterna delimitadora
Aplicação Ford Cargo e MB 14 / 16 / 18

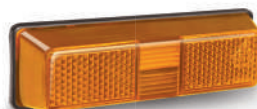

PL0426.21.01



PL0426.21.02



T4W (69)
Posição

Furos para encaixe em caminhões Ford e MB



Vista parte traseira

CÓDIGO	DESCRIÇÃO	COR	EMB.
PL0426.21.01	Lanterna delimitadora	Amarelo	20
PL0426.21.02	Lanterna delimitadora	Cristal	20



PL0426.31.01



PL0426.31.02



PL9913.17.97



T4W (69)
Posição

CÓDIGO	DESCRIÇÃO	COR	REF. ORIGINAL	EMB.
PL0426.31.01	Lanterna delimitadora	Amarelo	384 820 70 56	20
PL0426.31.02	Lanterna delimitadora	Cristal	-	20
REPOSIÇÃO	DESCRIÇÃO	REF. ORIGINAL		EMB.
PL9913.17.97	Soquete com 1 polo universal	MB 345.544.01.93 - VL 344-130		20



PL0426.21.41



PL0426.21.42

LED BIVOLT

CÓDIGO	DESCRIÇÃO	TENSÃO	COR	EMB.
PL0426.21.41	Lanterna delimitadora	LED BIVOLT	Amarelo	20
PL0426.21.42	Lanterna delimitadora	LED BIVOLT	Cristal	20

PL 0406

Lanterna delimitadora com pedestal
Aplicação Ford e universal



PL0406.37.05 - 2 polos

PL0406.00.05 - 1 polo



PY21W (1056)
Posição

CÓDIGO	DESCRIÇÃO	COR	EMB.
PL0406.37.05	Com 2 polos	Bicolor	10
PL0406.00.05	Com 1 polo para tratores	Bicolor	10



FORD CARGO 815/1119



PL 0270

Lanterna delimitadora com parafusos embutidos na base
Aplicação caminhões Ford / VW

LED BIVOLT



PL9913.17.97



CÓDIGO	DESCRIÇÃO	TENSÃO	COR	REF. ORIGINAL	EMB.
PL0270.00.02	Sem soquete	-	Cristal	2R2 945 341 A1	20
PL0270.00.42			Cristal	-	10
REPOSIÇÃO	DESCRIÇÃO	REF. ORIGINAL			EMB.
PL9913.17.97	Soquete com 1 polo universal	MB 345.544.01.93 - VL 344-130			20

PL 0470

Conjunto óptico
para lanternas delimitadoras PL0442 e PL0462



CÓDIGO	DESCRIÇÃO	COR	REF. ORIGINAL	EMB.
PL0470.00.02	Sem soquete	Cristal	154 4287 TU	20



CÓDIGO	DESCRIÇÃO	COR	REF. ORIGINAL	EMB.
PL0470.41.02	Com soquete	Cristal	2R2945341A1	20
REPOSIÇÃO	DESCRIÇÃO	REF. ORIGINAL		EMB.
PL9913.17.97	Soquete com 1 polo universal	MB 345.544.01.93 - VL 344-130		20



LED BIVOLT

CÓDIGO	DESCRIÇÃO	TENSÃO	COR	EMB.
PL0470.00.42	Conjunto óptico LED	LED BIVOLT	Cristal	05

PL 0462

Lanterna delimitadora
Aplicação Ford Cargo

Aplicação Ford Cargo Novo cabine simples

LED BIVOLT



PL0462.02.02 - LE



PL0462.02.42 - LE

CÓDIGO	DESCRIÇÃO	TENSÃO	LADO	COR	REF. ORIGINAL	EMB.
PL0462.01.02	Com soquete	-	Direito	Cristal	7C46 15K 490 BA	10
PL0462.02.02	Com soquete	-	Esquerdo	Cristal	7C46 15K 491 BA	10
PL0462.01.42	Com fios	LED BIVOLT	Direito	Cristal	-	10
PL0462.02.42	Com fios	LED BIVOLT	Esquerdo	Cristal	-	10

Aplicação Ford Cargo antigo

LED BIVOLT



PL0462.15.02



PL0462.15.42

CÓDIGO	DESCRIÇÃO	TENSÃO	COR	EMB.
PL0462.15.02	Com soquete e base reta		Cristal	10
PL0462.15.42	Com fios para adaptação e base reta	LED BIVOLT	Cristal	10



PL0462.21.02 - LD
PL0462.22.02 - LE



CÓDIGO	DESCRIÇÃO	LADO	COR	EMB.
PL0462.21.02	Com soquete (Ford 2004 e universal)	Direito	Cristal	10
PL0462.22.02	Com soquete (Ford 2004 e universal)	Esquerdo	Cristal	10

Aplicação Ford Cargo cabine estendida e teto alto.

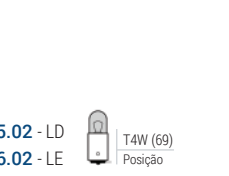

PL0462.35.02 - LD
PL0462.36.02 - LE



CÓDIGO	DESCRIÇÃO	LADO	COR	REF. ORIGINAL	EMB.
PL0462.35.02	Com soquete	Direito	Cristal	3C46 15K 490 AA	10
PL0462.36.02	Com soquete	Esquerdo	Cristal	3C46 15K 491 AA	10



FORD CARGO 2628 TRAÇADO

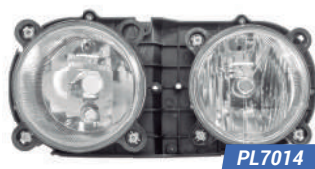

PL7014



PL0462

PL9913

Soquete disponível



PL0494

PL9934

Soquete disponível



PL0474

PL9995

Chicote disponível



PL0716

PL9999

Chicote disponível

PL 0440 LED

Lanterna traseira LED para caminhões Ford / VW



LED BIVOLT



PL0441.00.09

Lanterna traseira com lente lisa



LED BIVOLT



PL0441.23.09

CÓDIGO	DESCRIÇÃO	TENSÃO	LADO	COR	EMB.
PL0440.21.49	Com 22 LEDs - Sem vigia	LED BIVOLT	Direito	Tricolor	06
PL0440.22.49	Com 24 LEDs - Com vigia	LED BIVOLT	Esquerdo	Tricolor	06
REPOSIÇÃO	DESCRIÇÃO	COR	REF. ORIGINAL	EMB.	
PL0441.00.09	Lente para lanterna PL0440	Tricolor	T12 945 223 A	30	

CÓDIGO	DESCRIÇÃO	TENSÃO	LADO	COR	EMB.
PL0440.23.49	Com 22 LEDs e lente lisa - Sem vigia	LED BIVOLT	Direito	Tricolor	06
PL0440.24.49	Com 24 LEDs e lente lisa - Com vigia	LED BIVOLT	Esquerdo	Tricolor	06
REPOSIÇÃO	DESCRIÇÃO	Cor	EMB.		
PL0441.23.09	Lente lisa para lanterna PL0440	Tricolor	30		

PL 0440

Lanterna traseira para caminhões Ford / VW (VW de 89 a 2011)



PL0441.00.09



P21W (1141)
Luz de ré Direcional



P21/5W (1034)
Freio e Posição

Lanterna traseira com lente lisa



PL0441.23.09



P21W (1141)
Luz de ré Direcional



P21/5W (1034)
Freio e Posição

CÓDIGO	DESCRIÇÃO	LADO	COR	REF. ORIGINAL	EMB.
PL0440.01.09	Sem vigia	Direito	Tricolor	Ford 98HU13404AA - VW T12 945 096	06
PL0440.02.09	Com vigia	Esquerdo	Tricolor	Ford 98HU13405AA - VW T12 945 095	06
REPOSIÇÃO	DESCRIÇÃO	COR	REF. ORIGINAL	EMB.	
PL0441.00.09	Lente para lanterna PL0440	Tricolor	T12 945 223 A	30	

CÓDIGO	DESCRIÇÃO	LADO	COR	EMB.
PL0440.23.09	Com lente lisa - Sem vigia	Direito	Tricolor	06
PL0440.24.09	Com lente lisa - Com vigia	Esquerdo	Tricolor	06
REPOSIÇÃO	DESCRIÇÃO	Cor	EMB.	
PL0441.23.09	Lente lisa para lanterna PL0440	Tricolor	30	

Lanterna traseira com lente em acrílico



PL0441.00.29



P21W (1141)
Luz de ré Direcional



P21/5W (1034)
Freio e Posição

Lanterna traseira com lente bicolor



PL0441.00.07



P21W (1141)
Luz de ré



P21/5W (1034)
Freio e Posição



PY21W (1056)
Direcional

CÓDIGO	DESCRIÇÃO	Lente	LADO	COR	EMB.
PL0440.01.29	Sem vigia	Acrílica	Direito	Tricolor	06
PL0440.02.29	Com vigia	Acrílica	Esquerdo	Tricolor	06
REPOSIÇÃO	DESCRIÇÃO	LENTE	COR	EMB.	
PL0441.00.29	Lente para lanterna PL0440	Acrílica	Tricolor	30	

CÓDIGO	DESCRIÇÃO	LADO	COR	EMB.
PL0440.01.07	Sem vigia	Direito	Bicolor	06
PL0440.02.07	Com vigia	Esquerdo	Bicolor	06
REPOSIÇÃO	DESCRIÇÃO	Cor	EMB.	
PL0441.00.07	Lente lanterna PL0440	Bicolor	30	



FORD CARGO 1317



PL 0716
Lanterna traseira
Aplicação Ford / MB

LED BIVOLT



PL0716.21.49 - Sem vigia - LD
PL0716.22.49 - Com vigia - LE



PL0716.01.09 - Sem vigia - LD
PL0716.02.09 - Com vigia - LE



PL0717.33.09



PL0717.00.09
PL0717.00.29 - Lente acrílica

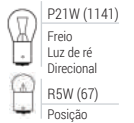

CÓDIGO	DESCRIÇÃO	TENSÃO	LADO	COR	EMB.
PL0716.21.49	Com 24 LEDs e lente com borda reforçada - Sem vigia	LED BIVOLT	Direito	Tricolor	01
PL0716.22.49	Com 26 LEDs e lente com borda reforçada - Com vigia	LED BIVOLT	Esquerdo	Tricolor	01

CÓDIGO	DESCRIÇÃO	LENTE	LADO	COR	REF. ORIGINAL	EMB.
PL0716.01.09	Sem vigia	PS	Direito	Tricolor	688 544 72 03	05
PL0716.02.09	Com vigia	PS	Esquerdo	Tricolor	688 544 71 03	05
REPOSIÇÃO	DESCRIÇÃO	LENTE	LADO	COR	REF. ORIGINAL	EMB.
PL0717.00.09	Lente refletiva	PS		Tricolor	002 544 18 90	15
PL0717.00.29	Lente refletiva	Acrílica		Tricolor	-	15

LED BIVOLT



PL0716.41.49 - Com conector 5 vias - Sem vigia - LD
PL0716.42.49 - Com conector 5 vias - Com vigia - LE



PL0716.41.29 - Com lente acrílica e sem vigia - LD
PL0716.42.29 - Com lente acrílica e com vigia - LE



PL0717.33.09



PL0717.00.29 - Lente acrílica



CÓDIGO	DESCRIÇÃO	TENSÃO	LADO	COR	EMB.
PL0716.41.49	Com 24 LEDs, conector 5 vias e lente com borda reforçada - Sem vigia	LED BIVOLT	Direito	Tricolor	01
PL0716.42.49	Com 26 LEDs, conector 5 vias e lente com borda reforçada - Com vigia	LED BIVOLT	Esquerdo	Tricolor	01
REPOSIÇÃO	DESCRIÇÃO			Cor	EMB.
PL0717.33.09	Lente refletiva com borda reforçada			Tricolor	15

CÓDIGO	DESCRIÇÃO	LENTE	LADO	COR	REF. ORIGINAL	EMB.
PL0716.41.29	com conector 5 vias - Sem vigia	Acrílica	Direito	Tricolor	688 544 92 03 ou CC 4513 405 AB	04
PL0716.42.29	com conector 5 vias - Com vigia	Acrílica	Esquerdo	Tricolor	688 544 91 03 ou CC 4513 404 AB	04
REPOSIÇÃO	DESCRIÇÃO			LENTE	COR	EMB.
PL0717.00.29	Lente refletiva			Acrílica	Tricolor	15



CAMINHÕES

GM DIRECIONAIS

PL 0306 Lanterna direcional Aplicação Chevrolet (até 88)



CÓDIGO	DESCRIÇÃO	COR	EMB.
PL0306.86.02	Com 2 polos e aro cromado	Cristal	20



CÓDIGO	DESCRIÇÃO	COR	EMB.
PL0306.85.02	Com 1 polo e aro cromado	Cristal	20



CÓDIGO	DESCRIÇÃO	COR	REF. ORIGINAL	EMB.
PL0306.83.02	Com 2 polos e aro preto	Cristal	73 175 75	20



CÓDIGO	DESCRIÇÃO	COR	REF. ORIGINAL	EMB.
PL0306.82.02	Com 1 polo e aro preto	Cristal	73 175 71	20



PL0301.00.02



PL0306.00.16

REPOSIÇÃO	DESCRIÇÃO	COR	REF. ORIGINAL	EMB.
PL0301.00.02	Lente para lanterna PL0306	Cristal	73 617 978	20
PL0306.00.16	Aro para lanterna PL0306	Cromado		25

PL 0420 Lanterna direcional Aplicação caminhões GM



PL0420.00.01



PL0409.00.01



CÓDIGO	DESCRIÇÃO	COR	REF. ORIGINAL	EMB.
PL0420.00.01	Lanterna direcional	Amarelo	94 630 600	12
PL0409.00.01	Lente para lanterna PL0420	Amarelo		20



CAMINHÕES

HYUNDAI TRASEIRAS

PL 0826 Lanterna traseira para caminhões Hyundai HR



Com conector e tampa de proteção tipo original



Vista parte traseira



- PL0826.01.29 - LD
- PL0826.02.29 - LE
- PL0826.41.29 - LD com chicote
- PL0826.42.29 - LE com chicote



PL9952.41.00

CÓDIGO	DESCRIÇÃO	LENTE	LADO	COR	REF. ORIGINAL	EMB.
PL0826.01.29	Lanterna traseira	Acrílica	Direito	Tricolor	924024F000	01
PL0826.02.29	Lanterna traseira	Acrílica	Esquerdo	Tricolor	924014F000	01
CÓDIGO	DESCRIÇÃO	LENTE	LADO	COR	REF. ORIGINAL	EMB.
PL0826.41.29	Lanterna traseira com chicote	Acrílica	Direito	Tricolor		01
PL0826.42.29	Lanterna traseira com chicote	Acrílica	Esquerdo	Tricolor		01
PL9952.41.00	Chicote completo para lanterna PL0826					10



CAMINHÕES

KIA TRASEIRAS

PL 0828 Lanterna traseira Aplicação Kia Bongo K2500 / K2700



PL0828.00.27



PL0828.49.27



PL9991.41.00

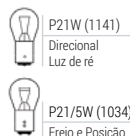

CÓDIGO	DESCRIÇÃO	LENTE	COR	REF. ORIGINAL	EMB.
PL0828.00.27	Sem chicote	Acrílica	Bicolor	-	01
PL0828.49.27	Com chicote	Acrílica	Bicolor	924014E020	01
REPOSIÇÃO	DESCRIÇÃO	LENTE	COR	REF. ORIGINAL	EMB.
PL9991.41.00	Chicote completo para lanterna PL0828				10





DAF XF



PL0692



PL0694



PL1620

Chicote disponível

PL9990

PL 0692

Lanterna direcional
Aplicação DAF XF



CÓDIGO	DESCRIÇÃO	LENTE	COR	REF. ORIGINAL	EMB.
PL0692.41.21	Com chicote	Acrílica	Amarelo	1815754	10

PL 0694

Lanterna delimitadora LED
Aplicação DAF XF



LED24V

CÓDIGO	DESCRIÇÃO	TENSÃO	LENTE	COR	REF. ORIGINAL	EMB.
PL0694.41.61	Com chicote	LED24V	Acrílica	Amarelo	1862083	10

PL 1620

Lanterna traseira
Aplicação DAF XF



PL1620.41.27 - LD

PL1620.42.27 - LE



PL1621.01.27 - LD

PL1621.02.27 - LE



PL9990.00.97

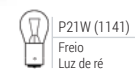

CÓDIGO	DESCRIÇÃO	LENTE	LADO	REF. ORIGINAL	EMB.
PL1620.41.27	Com conector - Sem vigia	Acrílica	Direito	1875578	01
PL1620.42.27	Com conector - Com vigia	Acrílica	Esquerdo	1875577	01
REPOSIÇÃO	DESCRIÇÃO	LENTE	LADO	COR	EMB.
PL1621.01.27	Lente para lanterna PL1620	Acrílica	Direito	Bicolor	02
PL1621.02.27	Lente para lanterna PL1620	Acrílica	Esquerdo	Bicolor	02
PL9990.00.97	Chicote com conector 8 vias tipo DAF				10

RENAULT
TRASEIRAS

CAMINHÕES



PL 0830

Lanterna traseira
Aplicação Renault Master Carga



PL0830.01.29 - LD

PL0830.02.29 - LE



Vista traseira



PL0831.00.29



CÓDIGO	DESCRIÇÃO	LADO	REF. ORIGINAL	EMB.
PL0830.01.29	Com conector tipo original - Sem vigia	Direito		01
PL0830.02.29	Com conector tipo original - Com vigia	Esquerdo		01
REPOSIÇÃO	DESCRIÇÃO	COR	REF. ORIGINAL	EMB.
PL0831.00.29	Lente para lanterna PL0830	Tricolor		01





IV STRALIS HD



PL 6024

Farol principal
Aplicação caminhões Stralis após 2010



PL6024.01.02 - Lado direito
PL6024.02.02 - Lado esquerdo



Conector tipo original



H1
Farol



WSW
Posição

Não acompanha lâmpada

CÓDIGO	DESCRIÇÃO	LADO	COR	REF. ORIGINAL	EMB.
PL6024.01.02	Farol principal	Direito	Cristal	504238093	01
PL6024.02.02	Farol principal	Esquerdo	Cristal	504238117	01

PL 0722

Lanterna direcional
Aplicação IV Eurotech



PL0722.01.22 - LD
PL0722.02.22 - LE



PL9918.17.96



P21W (1141)
Direcional

CÓDIGO	DESCRIÇÃO	LENTE	LADO	COR	REF. ORIGINAL	EMB.
PL0722.01.22	Lanterna direcional	Acrílica	Direito	Cristal	984 636 D	02
PL0722.02.22	Lanterna direcional	Acrílica	Esquerdo	Cristal	984 638 E	02
REPOSIÇÃO	DESCRIÇÃO					EMB.
PL9918.17.96	Soquete com 1 polo em nylon tipo IV					10

PL 0734

Lanterna direcional
Aplicação IV Stralis



PL0734.01.21 - LD
PL0734.02.21 - LE

PL0734.01.22 - LD
PL0734.02.22 - LE



P21W (1141)
Direcional



PY21W (1056)
Direcional

CÓDIGO	LENTE	LADO	COR	REF. ORIGINAL	EMB.
PL0734.01.21	Acrílico	Direito	Amarelo	41221039 / 504250984	02
PL0734.02.21	Acrílico	Esquerdo	Amarelo	41221029 / 504250958	02
PL0734.01.22	Acrílico	Direito	Cristal	-	02
PL0734.02.22	Acrílico	Esquerdo	Cristal	-	02

PL 0738

Lanterna direcional
Aplicação IV Stralis HD e Trakker



PL0738.01.22 - LD
PL0738.02.22 - LE



PL9918.17.96



P21W (1141)
Direcional

CÓDIGO	DESCRIÇÃO	LENTE	LADO	COR	REF. ORIGINAL	EMB.
PL0738.01.22	Lanterna direcional	Acrílico	Direito	Cristal	42555022	10
PL0738.02.22	Lanterna direcional	Acrílico	Esquerdo	Cristal	42555023	10
REPOSIÇÃO	DESCRIÇÃO					EMB.
PL9918.17.96	Soquete com 1 polo em nylon tipo IV					10



IV STRALIS



PL 0732

Lanterna direcional
Aplicação IV Stralis, Tector e Cursor



PL0732.01.01 - LD
PL0732.02.01 - LE



PL0732.01.02 - LD
PL0732.02.02 - LE



PL9918.17.96



CÓDIGO	DESCRIÇÃO	LADO	COR	REF. ORIGINAL	EMB.
PL0732.01.01	Lanterna direcional	Direito	Amarelo	42555041	06
PL0732.02.01	Lanterna direcional	Esquerdo	Amarelo	42555042	06
PL0732.01.02	Lanterna direcional	Direito	Cristal	-	06
PL0732.02.02	Lanterna direcional	Esquerdo	Cristal	-	06
REPOSIÇÃO	DESCRIÇÃO				EMB.
PL9918.17.96	Soquete com 1 polo em nylon tipo IV				10

PL 0742

Lanterna delimitadora LED
Aplicação IV Hi-Way



PL0742.41.62 - LD
PL0742.42.62 - LE



PL9946.17.00

CÓDIGO	DESCRIÇÃO	TENSÃO	LENTE	COR	REF. ORIGINAL	EMB.
PL0742.41.62	Com chicote	LED24V	Acrílica	Cristal	5801546522	01
PL0742.42.62	Com chicote	LED24V	Acrílica	Cristal	5801546548	01
REPOSIÇÃO	DESCRIÇÃO					EMB.
PL9946.17.00	Chicote universal com conector ultra seal 2 vias					10

LED24V

PL 0730

Lanterna delimitadora
Aplicação caminhões IV



PL0730.01.02 - LD
PL0730.02.02 - LE



PL9928.17.97

CÓDIGO	DESCRIÇÃO	LADO	COR	REF. ORIGINAL	EMB.
PL0730.01.02	Sem soquete	Direito	Cristal	504047265	10
PL0730.02.02	Sem soquete	Esquerdo	Cristal	504047264	10
REPOSIÇÃO	DESCRIÇÃO			REF. ORIGINAL	EMB.
PL9928.17.97	Soquete em nylon tipo VW para posição			90 443 393	20

PL 0748

Lanterna delimitadora
Aplicação caminhões IV

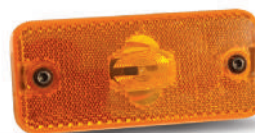

PL0748.41.21

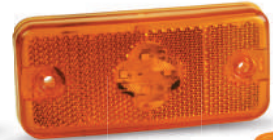

PL0748.00.61



CÓDIGO	TENSÃO	VOLTAGEM	LENTE	COR	REF. ORIGINAL	EMB.
PL0748.41.21	Com soquete	-	Acrílica	Amarelo	41200664	05
PL0748.00.61	Com soquete	LED BIVOLT	Acrílica	Amarelo	-	05

PL 0754

Lanterna delimitadora
Aplicação IV Tector e Cursor



PL0754.41.21



PL0755.00.21



PL9946.17.00

CÓDIGO	DESCRIÇÃO	LENTE	COR	REF. ORIGINAL	EMB.
PL0754.41.21	Com soquete	Acrílica	Amarelo	5801573146	01
REPOSIÇÃO	DESCRIÇÃO		LENTE	COR	EMB.
PL0755.00.21	Lente para lanterna PL0754		Acrílica	Amarelo	10
PL9946.17.00	Chicote universal com conector ultra seal 2 vias				10





IV TECTOR



PL 0720

Lanterna traseira
Aplicação IV



PL0720.13.09 - Sem vigia - LD
PL0720.14.09 - Com vigia - LE

Com fios para adaptação



Vista parte traseira

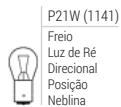

CÓDIGO	DESCRIÇÃO	LADO	EMB.
PL0720.13.09	Com cabos para adaptação - Sem vigia	Direito	03
PL0720.14.09	Com cabos para adaptação - Com vigia	Esquerdo	03

PL 0736

Lanterna traseira
Aplicação IV Pick-up Daily



PL0736.41.07 - LD
PL0736.42.07 - LE

Com conector tipo original



Vista parte traseira



CÓDIGO	DESCRIÇÃO	LADO	REF. ORIGINAL	EMB.
PL0736.41.07	Com conector tipo original - Sem vigia	Direito	69500026 ou 5801351224	01
PL0736.42.07	Com conector tipo original - Sem vigia	Esquerdo	69500032 ou 5801351218	01



PL0720.41.09 - Sem vigia - LD
PL0720.42.09 - Com vigia - LE

Com conector



Vista parte traseira

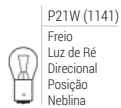

CÓDIGO	DESCRIÇÃO	LADO	REF. ORIGINAL	EMB.
PL0720.41.09	Com conector tipo original - Sem vigia	Direito	994 63243	03
PL0720.42.09	Com conector tipo original - Com vigia	Esquerdo	994 63242	03



PL0721.00.09



PL0737.00.07

REPOSIÇÃO	DESCRIÇÃO	COR	REF. ORIGINAL	EMB.	REPOSIÇÃO	DESCRIÇÃO	COR	REF. ORIGINAL	EMB.
PL0721.00.09	Lente para lanterna PL0720	Tricolor	931 61844	15	PL0737.00.07	Lente para lanterna PL0736	Bicolor	42555132	20



IV HI-WAY



PL0732

Soquete disponível



PL9918



PL1527



PL0742



PL0734



PL0748



PL0720

IV VERTIS



PL0730

Soquete disponível



PL9928



PL0736

PL 1527

Refletivo "olho de gato" 60mm



PL1527.00.21



PL1527.00.23

∅
60mm



Vista parte traseira



PL1527.21.21

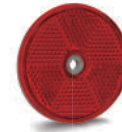

PL1527.21.23

∅
60mm



Vista parte traseira

CÓDIGO	DESCRIÇÃO	LENTE	COR	REF. ORIGINAL	EMB.	CÓDIGO	DESCRIÇÃO	LENTE	COR	EMB.
PL1527.00.21	Com parafuso	Acrílico	Amarelo	693 544 00 05	30	PL1527.21.21	Com furo central	Acrílico	Amarelo	30
PL1527.00.23	Com parafuso	Acrílico	Vermelho	-	30	PL1527.21.23	Com furo central	Acrílico	Vermelho	30



IV EUROTECH



PL0730

Soquete disponível

PL9928



PL0748



PL0722

Soquete disponível

PL9918



PL0734

IV CURSOR



PL6024



PL0730

Soquete disponível

PL9928



PL0732

Soquete disponível

PL9918



PL0754



PL1527



PL0720



MB AXOR



PL 6006

Farol auxiliar com conector tipo original
Aplicação MB Axor



PL6006.01.02 - LD
PL6006.02.02 - LE



Vista parte traseira



PL6007.01.02 - LD
PL6007.02.02 - LE

Com conector tipo original

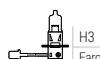

H3
Farol

Não acompanha lâmpada

CÓDIGO	DESCRIÇÃO	LADO	COR	REF. ORIGINAL	EMB.
PL6006.01.02	Com conector tipo original	Direito	Cristal	A9408200156	01
PL6006.02.02	Com conector tipo original	Esquerdo	Cristal	A9408200056	01
REPOSIÇÃO	DESCRIÇÃO	LADO	COR	REF. ORIGINAL	EMB.
PL6007.01.02	Lente em vidro para farol auxiliar PL6006	Direito	Cristal		01
PL6007.02.02	Lente em vidro para farol auxiliar PL6006	Esquerdo	Cristal		01

PL 6032

Farol principal com conectores e soquetes tipo originais
Aplicação MB Actros

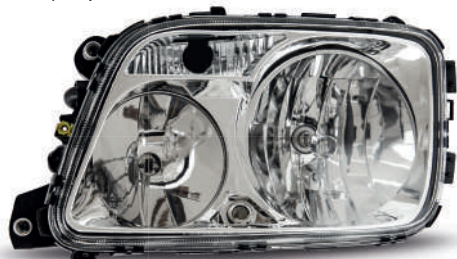

PL6032.01.22 - LD
PL6032.02.22 - LE

Vista parte traseira



H1
Farol



H7
Farol



PY21W (1056)
Direcional



WSW
Posição

Não acompanha lâmpada

CÓDIGO	DESCRIÇÃO	LADO	COR	REF. ORIGINAL	EMB.
PL6032.01.22	Com conector tipo original	Direito	Cristal	9438201461	01
PL6032.02.22	Com conector tipo original	Esquerdo	Cristal	9438201561	01

PL 6030

Farol principal com conectores e soquetes tipo originais
Aplicação MB Axor



PL6030.01.22 - LD
PL6030.02.22 - LE



Vista parte traseira



PL6031.01.16 - LD
PL6031.02.16 - LE



PL6031.01.22 - LD
PL6031.02.22 - LE



H1
Farol



H7
Farol

Não acompanha lâmpada

CÓDIGO	DESCRIÇÃO	LADO	COR	REF. ORIGINAL	EMB.
PL6030.01.22	Com conector tipo original	Direito	Cristal	9408200261	01
PL6030.02.22	Com conector tipo original	Esquerdo	Cristal	9408200161	01
REPOSIÇÃO	DESCRIÇÃO	LADO	REF. ORIGINAL	EMB.	
PL6031.01.16	Moldura para PL6030 e PL0592	Direito	9408851022	04	
PL6031.02.16	Moldura para PL6030 e PL0592	Esquerdo	9408850922	04	
PL6031.01.22	Lente em vidro para farol PL6030	Direito	-	01	
PL6031.02.22	Lente em vidro para farol PL6030	Esquerdo	-	01	

PL 6036

Farol DRL LED com conector tipo original
Aplicação MB Actros

LED24V



PL6036.01.62 - LD
PL6036.02.62 - LE

Vista parte traseira



CÓDIGO	DESCRIÇÃO	TENSÃO	LENTE	COR	REF. ORIGINAL	EMB.
PL6036.01.62	Com conector	LED24V	Acrílica	Cristal	9608201056	01
PL6036.02.62	Com conector	LED24V	Acrílica	Cristal	9608200956	01



MB ACTROS ATÉ 2015



PL6032



PL6038



PL1527



PL0612



PL0492



Chicote disponível

PL9998



PL0916



Chicote disponível

PL9947

PL 6038

Farol auxiliar com conector e soquete tipo original
Aplicação MB Actros



PL6038.01.22 - LD
PL6038.02.22 - LE



Vista parte traseira



H3
Farol

Não acompanha lâmpada

CÓDIGO	DESCRIÇÃO	LADO	COR	REF. ORIGINAL	EMB.
PL6038.01.22	Com conector tipo original	Direito	Cristal	9438200156	01
PL6038.02.22	Com conector tipo original	Esquerdo	Cristal	9438200056	01

PL 7031

Módulo óptico luz alta
Aplicação MB Actros de 2012 até 2021

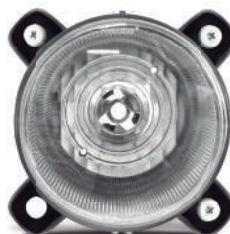

PL7031.01.22 - LD
PL7031.02.22 - LE



Vista parte traseira



H1
Farol

Não acompanha lâmpada

CÓDIGO	DESCRIÇÃO	LADO	COR	REF. ORIGINAL	EMB.
PL7031.01.22	Módulo óptico Farol luz alta	Direito	Cristal	789756350605 5	01
PL7031.02.22	Módulo óptico Farol luz alta	Esquerdo	Cristal	789756350603 1	01

PL 7002

Farol duplo
Aplicação MB 1620 / 710 / 712 / 715 / 812 / 814 a partir de 2000



PL7002.01.22 - LD
PL7002.02.22 - LE



Vista parte traseira



PL7003.01.22 - LD
PL7003.02.22 - LE



H1
Farol

Não acompanha lâmpada

CÓDIGO	DESCRIÇÃO	LADO	COR	REF. ORIGINAL	EMB.
PL7002.01.22	Farol duplo	Direito	Cristal	0160586 ou A6948200361	01
PL7002.02.22	Farol duplo	Esquerdo	Cristal	0160585 ou A6948200461	01
CÓDIGO	DESCRIÇÃO	LADO	COR	EMB.	
PL7003.01.22	Módulo óptico Farol	Direito	Cristal	01	
PL7003.02.22	Módulo óptico Farol	Esquerdo	Cristal	01	

PL 7004

Farol duplo
Aplicação MB 1714 / 1618 / 1215 / 2428 / 2423 / 914 / 915



PL7004.01.22 - LD
PL7004.02.22 - LE



Vista parte traseira



PL7003.01.22 - LD
PL7003.02.22 - LE



H1
Farol

Não acompanha lâmpada

CÓDIGO	DESCRIÇÃO	LADO	COR	REF. ORIGINAL	EMB.
PL7004.01.22	Farol duplo	Direito	Cristal	A6938200461	01
PL7004.02.22	Farol duplo	Esquerdo	Cristal	A6938200361	01
CÓDIGO	DESCRIÇÃO	LADO	COR	EMB.	
PL7003.01.22	Módulo óptico Farol	Direito	Cristal	01	
PL7003.02.22	Módulo óptico Farol	Esquerdo	Cristal	01	



MB ACTROS 2015 ATÉ 2019



PL 7026

Farol duplo
Com adaptador para soquete cachimbo
Aplicação MB Accelo a partir de 2008

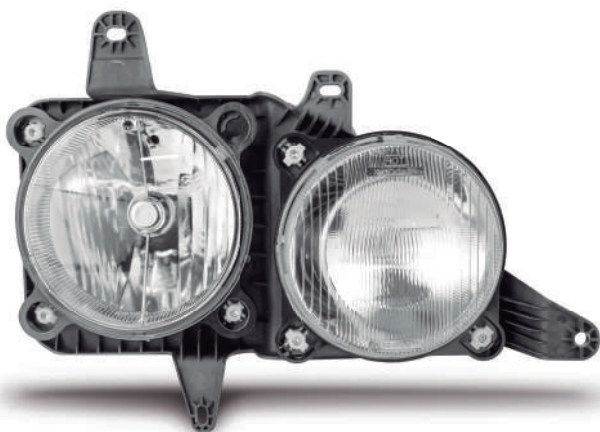

PL7026.01.22 - LD
PL7026.02.22 - LE



Vista parte traseira

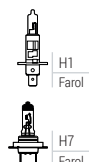

Não acompanha lâmpada

CÓDIGO	DESCRIÇÃO	LADO	COR	REF. ORIGINAL	EMB.
PL7026.01.22	Farol duplo	Direito	Cristal	A9798200461	01
PL7026.02.22	Farol duplo	Esquerdo	Cristal	A9798200361	01
CÓDIGO	DESCRIÇÃO	LADO	COR	REF. ORIGINAL	EMB.
PL7009.00.22	Módulo óptico Farol luz baixa		Cristal		01
PL7027.01.22	Módulo óptico Farol luz alta	Direito	Cristal		01
PL7027.02.22	Módulo óptico Farol luz alta	Esquerdo	Cristal		01

PL 7028

Farol duplo
Aplicação MB Atron de 2012 até 2021

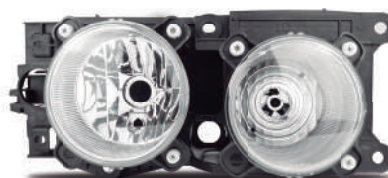

Vista parte traseira

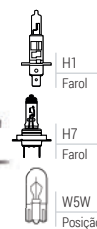

Não acompanha lâmpada

CÓDIGO	DESCRIÇÃO	LADO	COR	REF. ORIGINAL	EMB.
PL7028.01.22	Farol duplo	Direito	Cristal	A696.820.02.61	01
PL7028.02.22	Farol duplo	Esquerdo	Cristal	A696.820.01.61	01

Farol duplo com lanterna direcional
Aplicação MB Atron de 2012 até 2021

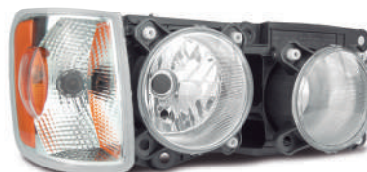

Vista parte traseira

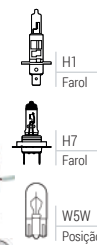

Não acompanha lâmpada

CÓDIGO	DESCRIÇÃO	LADO	COR	REF. ORIGINAL	EMB.
PL7028.91.22	Farol duplo	Direito	Cristal		01
PL7028.92.22	Farol duplo	Esquerdo	Cristal		01

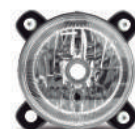

CÓDIGO	DESCRIÇÃO	LADO	REF. ORIGINAL	EMB.
PL0348.03.22	Lanterna direcional e delimitadora	Direito		01
PL0348.04.22	Lanterna direcional e delimitadora	Esquerdo		01
PL7029.01.22	Módulo óptico Farol luz alta	Direito	789756350605 5	01
PL7029.02.22	Módulo óptico Farol luz alta	Esquerdo	789756350603 1	01
PL7033.01.22	Módulo óptico Farol luz baixa	Direito	7897563506 0	01
PL7033.02.22	Módulo óptico Farol luz baixa	Esquerdo	789756350604 8	01
PL9928.17.97	Soquete em nylon para posição			20
PL9956.17.97	Soquete em nylon tipo MB para direcional			10
PL9987.41.00	Chicote completo MB para farol PL7028			10



MB 1620



PL7002



PL0532



PL0426



PL9913

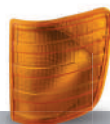

PL0448

Soquetes disponíveis



PL9924



PL9958

Chicote disponível



PL9996



PL0716

Chicote disponível

PL9999

PL 0408

Lanterna direcional
Aplicação MB e universal



PL0408.21.01

CÓDIGO	DESCRIÇÃO	COR	REF. ORIGINAL	EMB.
PL0408.21.01	Com base reta	Amarelo	331 822 70 20	15



P21W (1141)
Direcional

PL 0410

Lanterna direcional 3 faces
Aplicação MB e universal



PL0410.15.01



PL0410.15.02



PL0410.15.05



PL0408.35.05 - LD

CÓDIGO	DESCRIÇÃO	LADO	COR	EMB.
PL0408.35.05	Com base curva	Direito	Amarelo e Vermelho	15
PL0408.36.05	Com base curva	Esquerdo	Amarelo e Vermelho	15

REPOSIÇÃO	DESCRIÇÃO	COR	REF. ORIGINAL	EMB.
PL0409.00.01	Lente para lanterna PL0408	Amarelo	001 822 55 10	20
PL0409.00.02	Lente para lanterna PL0408	Cristal	-	20



PL0409.00.01



PL0409.00.02



PL0409.00.01



PL0409.00.02



P21W (1141)
Direcional

CÓDIGO	DESCRIÇÃO	COR	REF. ORIGINAL	EMB.
PL0410.15.01	Com base reta	Amarelo	350 820 70 05	06
PL0410.15.02	Com base reta	Cristal	-	06
PL0410.15.05	Com base reta	Amarelo e Vermelho	-	06

REPOSIÇÃO	DESCRIÇÃO	COR	REF. ORIGINAL	EMB.
PL0409.00.01	Lente para lanterna PL0408	Amarelo	001 822 55 10	20
PL0409.00.02	Lente para lanterna PL0408	Cristal	-	20

PL 0466

Lanterna direcional
Aplicação MB 1938S e MB Axor



PL0466.00.21



PL0466.00.22



P21W (1141)
Direcional



PY21W (1056)
Direcional



PL0466.41.21



P21W (1141)
Direcional



PY21W (1056)
Direcional



PL9917.37.94

CÓDIGO	DESCRIÇÃO	LENTE	COR	REF. ORIGINAL	EMB.
PL0466.00.21	Sem soquete	Polycarbonato	Amarelo	A 941 826 1021	05
PL0466.00.22	Sem soquete	Polycarbonato	Cristal	-	05

CÓDIGO	DESCRIÇÃO	LENTE	COR	EMB.
PL0466.41.21	Com soquete	Polycarbonato	Amarelo	05

REPOSIÇÃO	DESCRIÇÃO	EMB.
PL9917.37.94	Chicote com soquete de 2 polos tipo cachimbo MB e universal	10



MB 1938S-1944S



Chicote disponível

PL9917



Chicote disponível

PL9999

PL 0348

Lanterna direcional e delimitadora
Aplicação MB Atron



CÓDIGO	DESCRIÇÃO	LENTE	LADO	COR	REF. ORIGINAL	EMB.
PL0348.03.22	Sem soquete	Acrílica	Direito	Cristal	A 696 820 02 21	01
PL0348.04.22	Sem soquete	Acrílica	Esquerdo	Cristal	A 696 820 01 21	01
REPOSIÇÃO	DESCRIÇÃO				REF. ORIGINAL	EMB.
PL9928.17.97	Soquete em nylon para posição				90 443 393	20
PL9956.17.97	Soquete em nylon tipo MB para direcional					10

PL 1427

Refletivo traseiro
Aplicação ônibus, MB Accelo, Sprinter e universal

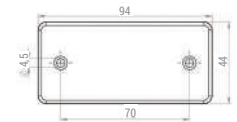

CÓDIGO	DESCRIÇÃO	LENTE	COR	REF. ORIGINAL	EMB.
PL1427.00.21	Refletivo traseiro	Acrílica	Amarelo	A0 008 262 240	30

PL 0518

Lanterna direcional
Aplicação MB 1718



PL0518.02.01 - LE

PL0518.04.02 - LE



CÓDIGO	DESCRIÇÃO	LENTE	COR	REF. ORIGINAL	EMB.
PL0476.00.35	Sem soquete	Acrílica	Amarelo e cinza	A 940 820 0221	05
PL0476.00.22	Sem soquete	Acrílica	Cristal	-	05



CÓDIGO	DESCRIÇÃO	LENTE	COR	EMB.
PL0476.41.35	Com soquete	Acrílica	Amarelo e cinza	05
REPOSIÇÃO	DESCRIÇÃO			EMB.
PL9917.37.94	Chicote com soquete de 2 polos tipo cachimbo MB e universal			10



CÓDIGO	DESCRIÇÃO	LADO	COR	REF. ORIGINAL	EMB.
PL0518.01.01	Sem soquete	Direito	Amarelo	688 820 7621	08
PL0518.02.01	Sem soquete	Esquerdo	Amarelo	688 820 7621	08
PL0518.03.02	Sem soquete	Direito	Cristal	-	08
PL0518.04.02	Sem soquete	Esquerdo	Cristal	-	08
REPOSIÇÃO	DESCRIÇÃO			REF. ORIGINAL	EMB.
PL9924.17.96	Soquete em nylon tipo VW para posição			VW 547 953 055-0	20
PL9958.17.00	Soquete 1 polo em nylon tipo MB para direcional				10
PL9996.17.97	Chicote com conector 2 vias para luz de posição				10



PL 0448

Lanterna direcional

Aplicação MB 14 / 16 / 18 (89 a 2011)

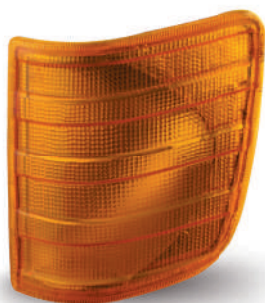

PL0448.01.01 - LD
PL0448.02.01 - LE

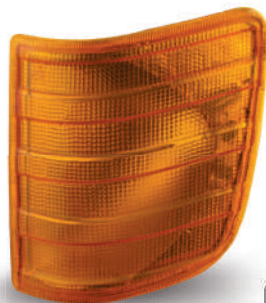

PL0448.45.01 com vigia - LD
PL0448.46.01 com vigia - LE



W5W
Posição



P21W (1141)
Direcional



PL0448.23.01 - LD
PL0448.24.01 - LE



PL0448.25.01 com vigia - LD
PL0448.26.01 com vigia - LE



W5W
Posição



P21W (1141)
Direcional

CÓDIGO	DESCRIÇÃO	LADO	COR	REF. ORIGINAL	EMB.
PL0448.01.01		Direito	Amarelo	384 820 71 21	10
PL0448.02.01		Esquerdo	Amarelo	384 820 70 21	10
PL0448.45.01	Com vigia	Direito	Amarelo	694 820 70 21	10
PL0448.46.01	Com vigia	Esquerdo	Amarelo	694 820 71 21	10

CÓDIGO	DESCRIÇÃO	LADO	COR	EMB.
PL0448.23.01	Com lente lisa	Direito	Amarelo	10
PL0448.24.01	Com lente lisa	Esquerdo	Amarelo	10
PL0448.25.01	Com lente lisa e vigia	Direito	Amarelo	10
PL0448.26.01	Com lente lisa e vigia	Esquerdo	Amarelo	10



PL0448.03.02 - LD
PL0448.04.02 - LE



PL0448.05.02 com vigia - LD
PL0448.06.02 com vigia - LE



W5W
Posição



P21W (1141)
Direcional



PL0448.23.02 - LD
PL0448.24.02 - LE



PL0448.25.02 com vigia - LD
PL0448.26.02 com vigia - LE



W5W
Posição



PY21W (1056)
Direcional

CÓDIGO	DESCRIÇÃO	LADO	COR	EMB.
PL0448.03.02	Com cúpula	Direito	Cristal	10
PL0448.04.02	Com cúpula	Esquerdo	Cristal	10
PL0448.05.02	Com cúpula e vigia	Direito	Cristal	10
PL0448.06.02	Com cúpula e vigia	Esquerdo	Cristal	10

CÓDIGO	DESCRIÇÃO	LADO	COR	EMB.
PL0448.23.02	Com lente lisa	Direito	Cristal	10
PL0448.24.02	Com lente lisa	Esquerdo	Cristal	10
PL0448.25.02	Com lente lisa e vigia	Direito	Cristal	10
PL0448.26.02	Com lente lisa e vigia	Esquerdo	Cristal	10



PL0448.03.04 - LD
PL0448.04.04 - LE



PL0448.05.04 com vigia - LD
PL0448.06.04 com vigia - LE



W5W
Posição



P21W (1141)
Direcional

CÓDIGO	DESCRIÇÃO	LADO	COR	REF. ORIGINAL	EMB.
PL0448.03.04	Com cúpula	Direito	Fumê	-	10
PL0448.04.04	Com cúpula	Esquerdo	Fumê	-	10
PL0448.05.04	Com cúpula e vigia	Direito	Fumê	384 821 71 21	10
PL0448.06.04	Com cúpula e vigia	Esquerdo	Fumê	384 721 70 20	10



PL0448.07.14 - LD
PL0448.08.14 - LE



Vista parte
traseira



PL9924.17.96



W5W
Posição



PL9996.17.97



PL9958.17.00



P21W (1141)
Direcional

REPOSIÇÃO	DESCRIÇÃO	LADO	COR	REF. ORIGINAL	EMB.
PL0448.07.14	Moldura em ABS com adesivo	Direito	Branca	-	10
PL0448.08.14	Moldura em ABS com adesivo	Esquerdo	Branca	-	10
PL9924.17.96	Soquete em nylon tipo VW para posição			VW 547 953 055-0	20
PL9958.17.00	Soquete 1 polo em nylon tipo MB para direcional			-	10
PL9996.17.97	Chicote com conector 2 vias para luz de posição			-	10



MB 1933



PL0408



PL0594



PL0516



PL0500

PL 0548

Lanterna direcional
Aplicação MB 1214 / 1721 (89 a 96)



PL0548.01.01 - LD
PL0548.02.01 - LE



P21W (1141)
Direcional

CÓDIGO	DESCRIÇÃO	LADO	COR	REF. ORIGINAL	EMB.
PL0548.01.01	Lanterna direcional	Direito	Amarelo	682 820 71 21	05
PL0548.02.01	Lanterna direcional	Esquerdo	Amarelo	682 820 70 21	05

PL 0498

Lanterna direcional
Aplicação MB Atego e Actros



PL0498.01.22 - LD
PL0498.02.22 - LE



PL9956.17.97



PY21W (1056)
Direcional

CÓDIGO	DESCRIÇÃO	LENTE	LADO	COR	REF. ORIGINAL	EMB.
PL0498.01.22	Sem soquete	Polycarbonato	Direito	Cristal	958 820 01 21	10
PL0498.02.22	Sem soquete	Polycarbonato	Esquerdo	Cristal	958 820 02 21	10
REPOSIÇÃO	DESCRIÇÃO	COR	REF. ORIGINAL	EMB.		
PL9956.17.97	Soquete em nylon tipo MB para direcional					10

PL 0612

Lanterna direcional e delimitadora
Aplicação MB Actros



PL0612.41.21

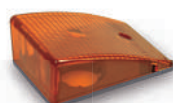

PL0612.60.21



PL9931.37.97



P21W (1141)
Direcional

CÓDIGO	DESCRIÇÃO	LENTE	COR	REF. ORIGINAL	EMB.
PL0612.41.21	Com conector	Acrílica	Amarelo	9418200521 Dir. 9418200921 Esq.	02
PL0612.60.21	Sem conector	Acrílica	Amarelo	-	02
REPOSIÇÃO	DESCRIÇÃO	COR	REF. ORIGINAL	EMB.	
PL9931.37.97	Chicote com conector e soquete 2 polos				01

PL 0450

Lanterna direcional
Aplicação MB 718 / 912 / 914 e universal



PL0450.00.01



PL0450.00.02



PL0451.00.01



PL0451.00.02



P21W (1141)
Direcional



PY21W (1056)
Direcional

CÓDIGO	DESCRIÇÃO	COR	REF. ORIGINAL	EMB.
PL0450.00.01	Lanterna direcional	Amarelo	688 820 70 56	10
PL0450.00.02	Lanterna direcional	Cristal	-	10
REPOSIÇÃO	DESCRIÇÃO	COR	REF. ORIGINAL	EMB.
PL0451.00.01	Lente para lanterna PL0450	Amarelo	000 820 00 56	20
PL0451.00.02	Lente para lanterna PL0450	Cristal	-	20

PL 0514

Lanterna direcional
Aplicação MB 1113 e MB 1114



PL0514.00.01



PL0514.00.02



PL0515.00.01



PL0515.00.02



P21W (1141)
Direcional



PY21W (1056)
Direcional

CÓDIGO	DESCRIÇÃO	COR	REF. ORIGINAL	EMB.
PL0514.00.01	Lanterna direcional	Amarelo	344 822 71 20	15
PL0514.00.02	Lanterna direcional	Cristal	-	15
REPOSIÇÃO	DESCRIÇÃO	COR	REF. ORIGINAL	EMB.
PL0515.00.01	Lente para lanterna PL0514	Amarelo	001 822 56 10	15
PL0515.00.02	Lente para lanterna PL0514	Cristal	-	15



MB 710-712-914



PL0532



PL0450



PL0528

Soquete disponível



PL9958



PL0716

Chicote disponível



PL9999

PL 0520

Lanterna direcional

Aplicação MB 1938S e 1944S

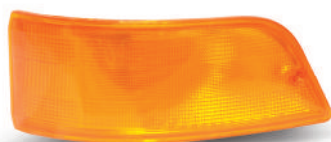

PL0520.01.01 - LD

PL0520.02.01 - LE

CÓDIGO	DESCRIÇÃO	LADO	COR	REF. ORIGINAL	EMB.
PL0520.01.01	Sem soquete	Direito	Amarelo	A 940 820 0121 D	02
PL0520.02.01	Sem soquete	Esquerdo	Amarelo	A 940 820 0021 E	02



PL0520.03.02 - LD

PL0520.04.02 - LE

CÓDIGO	DESCRIÇÃO	LADO	COR	EMB.
PL0520.03.02	Sem soquete e com cúpula	Direito	Cristal	02
PL0520.04.02	Sem soquete e com cúpula	Esquerdo	Cristal	02



PL9916.17.94



P21W (1141)
Direcional



PL9917.37.94

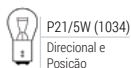

P21W (1034)
Direcional e Posição

REPOSIÇÃO	DESCRIÇÃO	EMB.
PL9916.17.94	Chicote com soquete de 1 polo tipo cachimbo MB e universal	10
PL9917.37.94	Chicote com soquete de 2 polos tipo cachimbo MB e universal	10

PL 0528

Lanterna direcional

Aplicação MB 708 / 709 / 710 / 712 / 912



PL0528.01.01 - LD

PL0528.02.01 - LE



PL0528.01.02 - LD

PL0528.02.02 - LE



PL9958.17.00



P21W (1141)
Direcional

CÓDIGO	DESCRIÇÃO	LADO	COR	REF. ORIGINAL	EMB.
PL0528.01.01	Sem soquete	Direito	Amarelo	688 820 71 21	10
PL0528.02.01	Sem soquete	Esquerdo	Amarelo	688 820 70 21	10
PL0528.01.02	Sem soquete	Direito	Cristal	-	10
PL0528.02.02	Sem soquete	Esquerdo	Cristal	-	10

REPOSIÇÃO	DESCRIÇÃO	EMB.
PL9958.17.00	Soquete 1 polo em nylon tipo MB para direcional	10

PL 0574

Lanterna direcional

Aplicação MB Accelo



PL0574.01.22 - LD

PL0574.02.22 - LE

CÓDIGO	DESCRIÇÃO	LENTE	LADO	COR	REF. ORIGINAL	EMB.
PL0574.01.22	Sem soquete	Acrílica	Direito	Cristal	A 979 820 0421 D	02
PL0574.02.22	Sem soquete	Acrílica	Esquerdo	Cristal	A 979 820 0321 E	02
REPOSIÇÃO	DESCRIÇÃO	REF. ORIGINAL	EMB.			
PL9924.17.96	Soquete em nylon tipo VW para posição	VW 547 953 055-0	20			
PL9996.17.97	Chicote com conector 2 vias para luz de posição	-	10			

PL9924.17.96

PL9996.17.97



W5W
Posição

PL 0576

Lanterna direcional

Aplicação MB Atego

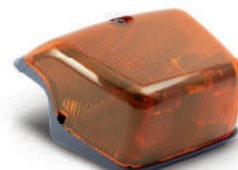

PL0576.01.21 - LD

PL0576.02.21 - LE



PL0576.01.22 - LD

PL0576.02.22 - LE



PL0577.01.21 - LD

PL0577.02.21 - LE



PL0577.01.22 - LD

PL0577.02.22 - LE



Vista parte traseira

PL9994.17.97



P21W (1141)
Direcional



PY21W (1056)
Direcional

CÓDIGO	DESCRIÇÃO	LENTE	LADO	COR	REF. ORIGINAL	EMB.
PL0576.01.21	Com conector	Acrílica	Direito	Amarelo	973 820 04 21	06
PL0576.02.21	Com conector	Acrílica	Esquerdo	Amarelo	973 820 03 21	06
PL0576.01.22	Com conector	Acrílica	Direito	Cristal	-	06
PL0576.02.22	Com conector	Acrílica	Esquerdo	Cristal	-	06

CÓDIGO	DESCRIÇÃO	LENTE	LADO	COR	EMB.
PL0577.01.21	Lente para lanterna PL0576	Acrílica	Direito	Amarelo	10
PL0577.02.21	Lente para lanterna PL0576	Acrílica	Esquerdo	Amarelo	10
PL0577.01.22	Lente para lanterna PL0576	Acrílica	Direito	Cristal	10
PL0577.02.22	Lente para lanterna PL0576	Acrílica	Esquerdo	Cristal	10
PL9994.17.97	Chicote com conector 2 vias tipo MB	-	-	-	10



MB ACCELO

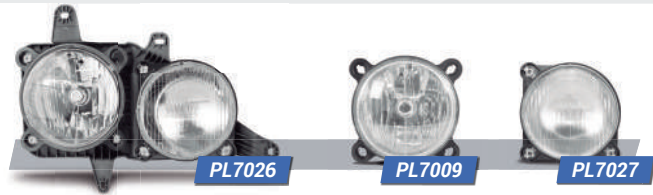

PL 0588
Lanterna direcional
Aplicação MB Atego



PL0588.01.02 - LD
PL0588.02.02 - LE
PL0588.01.22 - Lente acrílica LD
PL0588.02.22 - Lente acrílica LE



CÓDIGO	DESCRIÇÃO	LENTE	LADO	COR	REF. ORIGINAL	EMB.
PL0588.01.02	Sem soquete	PS	Direito	Cristal	973 820 06 21	02
PL0588.02.02	Sem soquete	PS	Esquerdo	Cristal	973 820 05 21	02
PL0588.01.22	Sem soquete	Acrílica	Direito	Cristal	-	02
PL0588.02.22	Sem soquete	Acrílica	Esquerdo	Cristal	-	02
REPOSIÇÃO	DESCRIÇÃO					EMB.
PL9922.17.96	Soquete em nylon tipo MB					10

PL 0592
Lanterna direcional
Aplicação MB Axor



PL0592.01.02 - LD
PL0592.02.02 - LE



CÓDIGO	DESCRIÇÃO	LADO	COR	REF. ORIGINAL	EMB.
PL0592.01.02	Sem soquete	Direito	Cristal	940 820 04 21	04
PL0592.02.02	Sem soquete	Esquerdo	Cristal	940 820 03 21	04

PL 0492
Lanterna delimitadora LED com refletivo e conector tipo original
Aplicação MB Atego e Actros

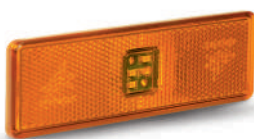

PL0492.24.61

LED 24V



Chicote disponível



PL9998.17.97

CÓDIGO	DESCRIÇÃO	TENSÃO	LENTE	COR	REF. ORIGINAL	EMB.
PL0492.24.61	Com conector	LED 24V	Acrílica	Amarelo	000 544 75 11	10
REPOSIÇÃO	DESCRIÇÃO					EMB.
PL9998.17.97	Chicote com conector 2 vias para lanternas LED					10

PL 0532
Lanterna delimitadora
Aplicação MB / 912



PL0532.00.07



Vista parte traseira



PL0533.00.02



PL0533.00.03



CÓDIGO	DESCRIÇÃO	COR	REF. ORIGINAL	EMB.
PL0532.00.07	Lanterna delimitadora	Vermelho e cristal	688 820 78 56	10
REPOSIÇÃO	DESCRIÇÃO			EMB.
PL0533.00.02	Lente para lanterna PL0532	Cristal		30
PL0533.00.03	Lente para lanterna PL0532	Vermelho		30

PL 0580
Lanterna delimitadora
Aplicação MB Atego, Accelo e Axor



PL0580.00.22



PL0580.00.62

LED 24V

CÓDIGO	TENSÃO	LENTE	LADO	COR	REF. ORIGINAL	EMB.
PL0580.00.22	-	Acrílica	Bilateral	Cristal	LD - 002 820 51 56 LE - 002 820 50 56	06
PL0580.00.62	LED BIVOLT	Acrílica	Bilateral	Cristal	-	06



MB ATEGO 2013...



PL 0426

Lanterna delimitadora
Aplicação Ford Cargo e MB 14 / 16 / 18



PL0426.21.01



PL0426.21.02



Furos para encaixe
em caminhões
Ford e MB



Vista parte traseira

CÓDIGO	DESCRIÇÃO	COR	EMB.
PL0426.21.01	Lanterna delimitadora	Amarelo	20
PL0426.21.02	Lanterna delimitadora	Cristal	20



PL0426.31.01



PL0426.31.02



PL9913.17.97



CÓDIGO	DESCRIÇÃO	COR	REF. ORIGINAL	EMB.
PL0426.31.01	Lanterna delimitadora	Amarelo	384 820 70 56	20
PL0426.31.02	Lanterna delimitadora	Cristal	-	20
REPOSIÇÃO	DESCRIÇÃO	REF. ORIGINAL	EMB.	
PL9913.17.97	Soquete com 1 polo universal	MB 345.544.01.93 - VL 344-130	20	

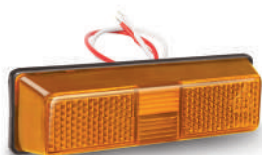

PL0426.21.41

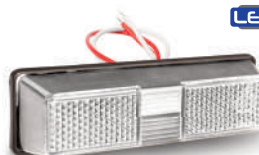

PL0426.21.42

CÓDIGO	DESCRIÇÃO	TENSÃO	COR	EMB.
PL0426.21.41	Lanterna delimitadora	LED BIVOLT	Amarelo	20
PL0426.21.42	Lanterna delimitadora	LED BIVOLT	Cristal	20

PL 0510

Lanterna delimitadora
Aplicação MB e universal

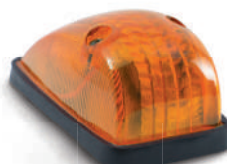

PL0510.15.01

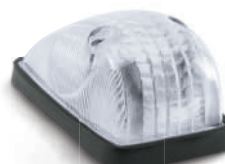

PL0510.15.02



Vista parte traseira

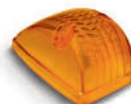

PL0511.00.01



PL0511.00.02



CÓDIGO	DESCRIÇÃO	COR	REF. ORIGINAL	EMB.
PL0510.15.01	Com base reta	Amarelo	308 822 01 20	30
PL0510.15.02	Com base reta	Cristal	-	30
REPOSIÇÃO	DESCRIÇÃO	COR	REF. ORIGINAL	EMB.
PL0511.00.01	Lente para lanterna PL0510	Amarelo	98 000 822 86 10	25
PL0511.00.02	Lente para lanterna PL0510	Cristal	-	25

PL 0594

Lanterna delimitadora
Aplicação MB (a partir de 84)



PL0594.00.01



PL0594.00.02



PL0595.00.01



PL0595.00.02



CÓDIGO	DESCRIÇÃO	COR	REF. ORIGINAL	EMB.
PL0594.00.01	Com base reta	Amarelo	331 826 71 47	10
PL0594.00.02	Com base reta	Cristal	331 826 73 47	10
REPOSIÇÃO	DESCRIÇÃO	COR	REF. ORIGINAL	EMB.
PL0595.00.01	Lente para lanterna PL0594	Amarelo	331 826 70 10	20
PL0595.00.02	Lente para lanterna PL0594	Cristal	331 826 72 10	20



MB ATEGO 2006 até 2012



PL 0428

Lanterna interna de cabine
Aplicação caminhões MB



CÓDIGO	DESCRIÇÃO	COR	REF. ORIGINAL	EMB.
PL0428.20.14	Lanterna interna de cabine	Branca	331 825 73 01	15
REPOSIÇÃO	DESCRIÇÃO		COR	EMB.
PL0429.20.14	Lente com interruptor		Branca	05
PL0429.00.14	Lente sem interruptor		Branca	05

PL 0500

Lanterna traseira
Aplicação MB 1113 (até 88)



CÓDIGO	DESCRIÇÃO	LADO	COR	REF. ORIGINAL	EMB.
PL0500.01.05	Sem vigia	Direito	Vermelho e Amarelo	344 544 71 03	12
PL0500.02.05	Com vigia	Esquerdo	Vermelho e Amarelo	344 544 70 03	12
CÓDIGO	DESCRIÇÃO		COR	REF. ORIGINAL	EMB.
PL0501.00.05	Lente para lanterna PL0500		Vermelho e Amarelo	044 544 00 89	15

PL 0516

Lanterna traseira
Aplicação MB 1313 e universal



CÓDIGO	DESCRIÇÃO	LADO	COR	REF. ORIGINAL	EMB.
PL0516.01.05	Sem vigia	Direito	Vermelho e Amarelo	344 544 71 03	08
PL0516.02.05	Com vigia	Esquerdo	Vermelho e Amarelo	344 544 70 03	08

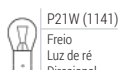

CÓDIGO	DESCRIÇÃO	LADO	COR	REF. ORIGINAL	EMB.
PL0516.01.09	Sem vigia	Direito	Tricolor	008 544 00 90	08
PL0516.02.09	Com vigia	Esquerdo	Tricolor	008 544 00 90	08



REPOSIÇÃO	DESCRIÇÃO	COR	REF. ORIGINAL	EMB.
PL0517.00.05	Lente para lanterna PL0516	Vermelho e Amarelo	008 544 00 90	20
PL0517.00.09	Lente para lanterna PL0516	Tricolor	-	20

PL 0786

Lanterna traseira
Aplicação universal tipo MB



Desenho moderno



CÓDIGO	DESCRIÇÃO	LADO	COR	EMB.
PL0786.01.05	Sem vigia	Direito	Vermelho e Amarelo	08
PL0786.02.05	Com vigia	Esquerdo	Vermelho e Amarelo	08



CÓDIGO	DESCRIÇÃO	LADO	COR	EMB.
PL0786.01.09	Sem vigia	Direito	Tricolor	08
PL0786.02.09	Com vigia	Esquerdo	Tricolor	08

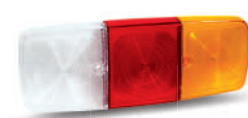

REPOSIÇÃO	DESCRIÇÃO	COR	EMB.
PL0787.00.05	Lente para lanterna PL0786	Vermelho e Amarelo	10
PL0787.00.09	Lente para lanterna PL0786	Tricolor	10



MB ATRON 1719 / 2729

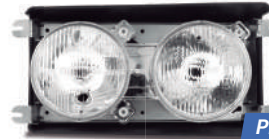

PL7004



PL0532

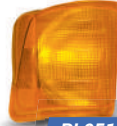

PL0518



PL9924



PL9958

Soquetes disponíveis



PL9996

Chicote disponível



PL0716



PL9999

Chicote disponível

PL 0716 LED

Lanterna traseira LED
Aplicação Ford / MB

LED BIVOLT



PL0716.21.49 - Sem vigia - LD
PL0716.22.49 - Com vigia - LE

LED BIVOLT



PL0716.23.49 - Com lente lisa - Sem vigia - LD
PL0716.24.49 - Com lente lisa - Com vigia - LE



PL0717.33.09



PL0717.23.09

CÓDIGO	DESCRIÇÃO	TENSÃO	LADO	COR	EMB.
PL0716.21.49	Com 24 LEDs e lente com borda reforçada Sem vigia	LED BIVOLT	Direito	Tricolor	01
PL0716.22.49	Com 26 LEDs e lente com borda reforçada Com vigia	LED BIVOLT	Esquerdo	Tricolor	01
REPOSIÇÃO	DESCRIÇÃO			Cor	EMB.
PL0717.33.09	Lente refletiva com borda reforçada			Tricolor	15

CÓDIGO	DESCRIÇÃO	TENSÃO	LADO	COR	EMB.
PL0716.23.49	Com 24 LEDs e lente lisa - Sem vigia	LED BIVOLT	Direito	Tricolor	01
PL0716.24.49	Com 26 LEDs e lente lisa - Com vigia	LED BIVOLT	Esquerdo	Tricolor	01
REPOSIÇÃO	DESCRIÇÃO			Cor	EMB.
PL0717.23.09	Lente lisa			Tricolor	15

LED BIVOLT



PL0716.41.49 - Com conector 5 vias - Sem vigia - LD
PL0716.42.49 - Com conector 5 vias - Com vigia - LE

LED BIVOLT



PL0716.47.49 - Com lente lisa - Sem vigia - LD
PL0716.48.49 - Com lente lisa - Com vigia - LE



PL0717.33.09



PL9999.17.97



Com conector 5 vias



PL0717.23.09



PL9947.39.00



Com conector 7 vias

CÓDIGO	DESCRIÇÃO	TENSÃO	LADO	COR	EMB.
PL0716.41.49	Com 24 LEDs, conector 5 vias e lente com borda reforçada - Sem vigia	LED BIVOLT	Direito	Tricolor	01
PL0716.42.49	Com 26 LEDs, conector 5 vias e lente com borda reforçada - Com vigia	LED BIVOLT	Esquerdo	Tricolor	01
CÓDIGO	DESCRIÇÃO			Cor	EMB.
PL0717.33.09	Lente refletiva com borda reforçada			Tricolor	15
PL9999.17.97	Chicote com conector 5 vias fêmea				10

CÓDIGO	DESCRIÇÃO	TENSÃO	LADO	COR	EMB.
PL0716.47.49	Com 24 LEDs, conector 7 vias e lente lisa - Sem vigia	LED BIVOLT	Direito	Tricolor	01
PL0716.48.49	Com 26 LEDs, conector 7 vias e lente lisa - Com vigia	LED BIVOLT	Esquerdo	Tricolor	01
REPOSIÇÃO	DESCRIÇÃO			Cor	EMB.
PL0717.23.09	Lente lisa com borda reforçada			Tricolor	15
PL9947.39.00	Chicote 7 vias fêmea com 20cm de cabos				10



MB ATRON 1319 / 1635 / 2324



PL 0716

Lanterna traseira para caminhões Ford / MB

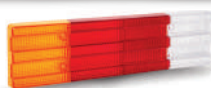

PL0717.00.09
PL0717.00.29 - Lente acrílica

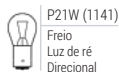

CÓDIGO	DESCRIÇÃO	LENTE	LADO	COR	REF. ORIGINAL	EMB.
PL0716.01.09	Sem vigia	PS	Direito	Tricolor	688 544 72 03	05
PL0716.02.09	Com vigia	PS	Esquerdo	Tricolor	688 544 71 03	05
REPOSIÇÃO	DESCRIÇÃO	LENTE	COR	REF. ORIGINAL	EMB.	
PL0717.00.09	Lente refletiva	PS	Tricolor	002 544 18 90	15	
PL0717.00.29	Lente refletiva	Acrílica	Tricolor	-	15	



PL0717.33.09

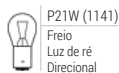

CÓDIGO	DESCRIÇÃO	LADO	COR	EMB.
PL0716.21.09	Com lente de borda reforçada - Sem vigia	Direito	Tricolor	05
PL0716.22.09	Com lente de borda reforçada - Com vigia	Esquerdo	Tricolor	05
REPOSIÇÃO	DESCRIÇÃO	Cor	EMB.	
PL0717.33.09	Lente refletiva com borda reforçada	Tricolor	15	



PL0717.23.09

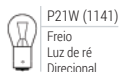

CÓDIGO	DESCRIÇÃO	LADO	COR	EMB.
PL0716.23.09	Com lente lisa - Sem vigia	Direito	Tricolor	05
PL0716.24.09	Com lente lisa - Com vigia	Esquerdo	Tricolor	05
REPOSIÇÃO	DESCRIÇÃO	Cor	EMB.	
PL0717.23.09	Lente lisa	Tricolor	15	



PL0715.00.17

REPOSIÇÃO	DESCRIÇÃO	Cor	EMB.
PL0715.00.17	Máscara em ABS para lanternas PL0716	Preta	10
PL0717.33.07	Lente refletiva com borda reforçada	Bicolor	15



PL0717.33.07



PL0717.33.09



PL9947.39.00



CÓDIGO	DESCRIÇÃO	LADO	COR	REF. ORIGINAL	EMB.
PL0716.47.09	Com conector 7 vias e borda reforçada - Sem vigia	Direito	Tricolor	958 540 01 70	05
PL0716.48.09	Com conector 7 vias e borda reforçada - Com vigia	Esquerdo	Tricolor	958 540 02 70	05
REPOSIÇÃO	DESCRIÇÃO	Cor	EMB.		
PL0717.33.09	Lente refletiva com borda reforçada	Tricolor	15		
PL9947.39.00	Chicote 7 vias fêmea com 20cm de cabos		10		



PL0717.00.29 - Lente acrílica



PL9999.17.97



CÓDIGO	DESCRIÇÃO	LENTE	LADO	COR	REF. ORIGINAL	EMB.
PL0716.41.29	com conector 5 vias - Sem vigia	Acrílica	Direito	Tricolor	688 544 92 03 ou CC 4513 405 AB	04
PL0716.42.29	com conector 5 vias - Com vigia	Acrílica	Esquerdo	Tricolor	688 544 91 03 ou CC 4513 404 AB	04
REPOSIÇÃO	DESCRIÇÃO	LENTE	COR	EMB.		
PL0717.00.29	Lente refletiva	Acrílica	Tricolor	15		
PL9999.17.97	Chicote com conector 5 vias fêmea			10		



PL0717.33.09



PL9999.17.97



CÓDIGO	DESCRIÇÃO	LADO	COR	EMB.
PL0716.31.09	com conector 5 vias e borda reforçada - Sem vigia	Direito	Tricolor	04
PL0716.32.09	com conector 5 vias e borda reforçada - Com vigia	Esquerdo	Tricolor	04
CÓDIGO	DESCRIÇÃO	COR	EMB.	
PL0717.33.09	Lente refletiva com borda reforçada	Tricolor	15	
PL9999.17.97	Chicote com conector 5 vias fêmea		10	



MB 1214 1721



PL0532



PL0548



PL1427



PL0716

Chicote disponível

PL9999

PL 0912 LED

Lanterna traseira LED com conector tipo original
Aplicação MB Axor, Accelo e Atego

LED24V



PL0913.00.29



PL9986.00.97

CÓDIGO	DESCRIÇÃO	TENSÃO	LENTE	LADO	COR	EMB.
PL0912.33.69	Com 64 LEDs, sem sirene de ré e sem vigia	LED24V	Acrílica	Direito	Tricolor	01
PL0912.34.69	Com 70 LEDs, sem sirene de ré e com vigia	LED24V	Acrílica	Esquerdo	Tricolor	01
REPOSIÇÃO	DESCRIÇÃO	LENTE	COR	REF. ORIGINAL	EMB.	
PL0913.00.29	Lente para lanterna PL0912	Acrílica	Tricolor	A 002 544 63 03	10	
PL9986.00.97	Chicote com conector 7 vias tipo MB			-	10	

PL 0912

Lanterna traseira com conector tipo original
Aplicação MB Actros, Accelo Atego e Axor



- PL0912.31.29 - Com sirene - Sem vigia - LD
- PL0912.41.29 - Sem sirene - Sem vigia - LD
- PL0912.42.29 - Sem sirene - Com vigia - LE



PL0913.00.29



PL9986.00.97

CÓDIGO	DESCRIÇÃO	LENTE	LADO	COR	REF. ORIGINAL	EMB.
PL0912.31.29	Com sirene de ré Sem vigia	Acrílica	Direito	Tricolor	A 003 544 10 03	01
PL0912.41.29	Sem sirene de ré Sem vigia	Acrílica	Direito	Tricolor	A 003 544 08 03	01
PL0912.42.29	Sem sirene de ré Com vigia	Acrílica	Esquerdo	Tricolor	A 003 544 61 03	01
REPOSIÇÃO	DESCRIÇÃO	LENTE	COR	REF. ORIGINAL	EMB.	
PL0913.00.29	Lente para lanterna PL0912	Acrílica	Tricolor	A 002 544 63 03	10	
PL9986.00.97	Chicote com conector 7 vias tipo MB			-	10	



P21W (1141)



RSW (67)

PL 0916

Lanterna traseira
Aplicação MB Axor e Actros



- PL0916.41.09 - Sem vigia - LD
- PL0916.42.09 - Com vigia - LE



- PL0917.01.09 - sem vigia - LD
- PL0917.02.09 - com vigia - LE



Vista parte lateral



PL9947.39.00

P21W (1141)

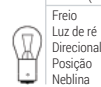

RSW (67) Posição

CÓDIGO	DESCRIÇÃO	LADO	COR	REF. ORIGINAL	EMB.
PL0916.41.09	Com conector - Sem vigia	Direito	Tricolor	A 001 540 63 70	01
PL0916.42.09	Com conector - Com vigia	Esquerdo	Tricolor	A 001 540 62 70	01
REPOSIÇÃO	DESCRIÇÃO	EMB.			
PL9947.39.00	Chicote 7 vias fêmea com 20cm de cabos	10			



- PL0916.13.09 - Sem vigia - LD
- PL0916.14.09 - Com vigia - LE



- PL0917.01.09 - sem vigia - LD
- PL0917.02.09 - com vigia - LE



Vista parte lateral

P21W (1141)

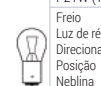

RSW (67) Posição

CÓDIGO	DESCRIÇÃO	LADO	COR	EMB.	
PL0916.13.09	Com terminais para adaptação - Sem vigia	Direito	Tricolor	01	
PL0916.14.09	Com terminais para adaptação - Com vigia	Esquerdo	Tricolor	01	
CÓDIGO	DESCRIÇÃO	LADO	COR	REF. ORIGINAL	EMB.
PL0917.01.09	Lente para Lanterna PL0916	Direito	Tricolor	A 002 544 16 90	LD 10
PL0917.02.09	Lente para Lanterna PL0916	Esquerdo	Tricolor	A 002 544 12 90	LD 10



SC SÉRIE 5



PL6028



PL0478

Soquete disponível

PL9955



PL1442

Chicote disponível

PL9947

PL 6016

Farol auxiliar de neblina e milha com soquete tipo original
Aplicação SC 124



H1
Farol

Não acompanha lâmpada

CÓDIGO	DESCRIÇÃO	LADO	COR	REF. ORIGINAL	EMB.
PL6016.01.02	Farol auxiliar de neblina e milha	Direito	Cristal	1529071	01
PL6016.02.02	Farol auxiliar de neblina e milha	Esquerdo	Cristal	1529070	01

PL 6028

Farol principal
Aplicação caminhões Série 5 / 6



Conector tipo original



H1
Farol

Não acompanha lâmpada

CÓDIGO	DESCRIÇÃO	LADO	COR	REF. ORIGINAL	EMB.
PL6028.01.02	Farol principal	Direito	Cristal	1949908	01
PL6028.02.02	Farol principal	Esquerdo	Cristal	1949906	01

PL 6042

Farol principal com soquete tipo original
Aplicação SC NTG

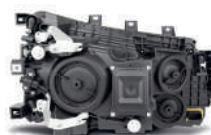

Conector tipo original



H21W Direcional
H1 Farol alto Farol baixo

Não acompanha lâmpada

CÓDIGO	DESCRIÇÃO	LADO	COR	REF. ORIGINAL	EMB.
PL6042.01.02	Farol principal	Direito	Cristal	1EH014541061	01
PL6042.02.02	Farol principal	Esquerdo	Cristal	1EH014541051	01

PL 0446

Lanterna direcional e delimitadora
Aplicação SC 112 / 113



PL0446.01.06 - LD
PL0446.02.06 - LE

PL0447.01.06 - LD
PL0447.02.06 - LE



P21W (1141)
Direcional

CÓDIGO	DESCRIÇÃO	LADO	COR	REF. ORIGINAL	EMB.
PL0446.01.06	Sem refletivo	Direito	Amarelo e cristal	289 928	07
PL0446.02.06	Sem refletivo	Esquerdo	Amarelo e cristal	289 927	07
REPOSIÇÃO	DESCRIÇÃO	LADO	COR	REF. ORIGINAL	EMB.
PL0447.01.06	Lente para PL0446	Direito	Amarelo e cristal	1 953 507	12
PL0447.02.06	Lente para PL0446	Esquerdo	Amarelo e cristal	1 953 508	12



PL0446.11.06 - LD
PL0446.12.06 - LE



PL0447.11.06 - LD
PL0447.12.06 - LE



P21W (1141)
Direcional

CÓDIGO	DESCRIÇÃO	LADO	COR	REF. ORIGINAL	EMB.
PL0446.11.06	Com refletivo	Direito	Amarelo e cristal	394767	07
PL0446.12.06	Com refletivo	Esquerdo	Amarelo e cristal	394766	07
REPOSIÇÃO	DESCRIÇÃO	LADO	COR	REF. ORIGINAL	EMB.
PL0447.11.06	Lente com refletivo para PL0446	Direito	Amarelo e cristal		12
PL0447.12.06	Lente com refletivo para PL0446	Esquerdo	Amarelo e cristal		12



PL0446.11.04 - LD
PL0446.12.04 - LE



PL0447.11.04 - LD
PL0447.12.04 - LE



P21W (1141)
Direcional

CÓDIGO	DESCRIÇÃO	LADO	COR	REF. ORIGINAL	EMB.
PL0446.11.04	Com refletivo	Direito	Fumê	526618	07
PL0446.12.04	Com refletivo	Esquerdo	Fumê	526617	07
REPOSIÇÃO	DESCRIÇÃO	LADO	COR	REF. ORIGINAL	EMB.
PL0447.11.04	Lente com refletivo para PL0446	Direito	Fumê		12
PL0447.12.04	Lente com refletivo para PL0446	Esquerdo	Fumê		12



SC SÉRIE 4 - 124



PL6016



PL1446

Chicote disponível



PL9954



PL0484



PL1614

SC SÉRIE 5



PL6028



PL0478

Soquete disponível



PL9955



PL1616

Chicote disponível



PL9947

PL 0478

Lanterna direcional
Aplicação SC Série 5



PL0478.00.21

CÓDIGO	DESCRIÇÃO	LENTE	COR	REF. ORIGINAL	EMB.
PL0478.00.21	Sem soquete	Acrílica	Amarelo	1774632	06



P21W (1141)
Direcional



PL0478.41.21

CÓDIGO	DESCRIÇÃO	LENTE	COR	REF. ORIGINAL	EMB.
PL0478.41.21	Com soquete	Acrílica	Amarelo	1770301	06
REPOSIÇÃO	DESCRIÇÃO				
PL9955.17.00	Soquete com 1 polo tipo SC				10



PL9955.17.00



P21W (1141)
Direcional

PL 1446

Lanterna direcional
Aplicação SC Série 4 Hella e Cibie



PL1446.01.02 - LD

PL1446.02.02 - LE

CÓDIGO	DESCRIÇÃO	LADO	COR	Ref. Original	EMB.
PL1446.01.02	Lanterna direcional	Direito	Cristal	1349784 ou 1407946	08
PL1446.02.02	Lanterna direcional	Esquerdo	Cristal	1349783 ou 1407945	08
REPOSIÇÃO	DESCRIÇÃO				
PL9954.17.00	Chicote com 4 soquetes padrão Hella e conector				05



PL9954.17.00



P21W (1141)
Posição



R5W (67)
Direcional
Posição



SC SÉRIE 113



PL 0444
Lanterna interna de cabine
Aplicação SC 142 / 143



PL0444.00.14



C5W
Interna

CÓDIGO	DESCRIÇÃO	COR	REF. ORIGINAL	EMB.
PL0444.00.14	Lanterna interna de cabine	Branca	296 086	06

PL 0484
Lanterna delimitadora com refletivo
Aplicação SC Série 4

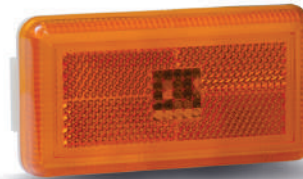

PL0484.00.01

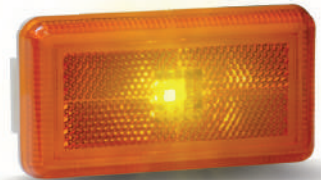

PL0484.00.41



CÓDIGO	DESCRIÇÃO	TENSÃO	COR	Ref. Original	EMB.
PL0484.00.01	Com refletivo	-	Amarelo	1362707	10
PL0484.00.41	Com refletivo	LED BIVOLT	Amarelo		10

PL 0438
Lanterna delimitadora
Aplicação SC 113



PL0438.00.02



PL9911.17.97



R5W (67)
Posição

CÓDIGO	DESCRIÇÃO	COR	REF. ORIGINAL	EMB.
PL0438.00.02	Lanterna delimitadora sem soquete	Cristal	199 846	10
REPOSIÇÃO	DESCRIÇÃO			EMB.
PL9911.17.97	Chicote com soquete de 1 polo tipo ônibus			10

PL 0540
Lanterna delimitadora
Aplicação SC (a partir de 94)



PL0540.00.07



Vista parte traseira

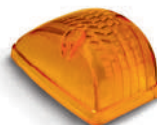

PL0511.00.01



P21W (1141)
Posição



R5W (67)
Posição

PL 0510
Lanterna delimitadora
Aplicação SC 111



PL0510.35.01

CÓDIGO	DESCRIÇÃO	COR	REF. ORIGINAL	EMB.
PL0510.35.01	Com base curva	Amarelo	61 503	10
REPOSIÇÃO	DESCRIÇÃO	COR <th>REF. ORIGINAL</th> <th>EMB.</th>	REF. ORIGINAL	EMB.
PL0511.00.01	Lente para lanterna PL0510	Amarelo	98 000 822 86 10	25



Vista parte traseira



R5W (67)
Posição

CÓDIGO	DESCRIÇÃO	COR	REF. ORIGINAL	EMB.
PL0540.00.07	Com base curva	Vermelho e cristal	301844	5



SC SÉRIE 113



PL0540



PL0446



PL0614

PL 0750

Lanterna delimitadora LED com refletivo
Aplicação SC Série 6

LED24V



PL0750.24.61



Vista parte traseira

Chicote disponível



PL9998.17.97

CÓDIGO	DESCRIÇÃO	TENSÃO	LENTE	COR	Ref. Original	EMB.
PL0750.24.61	Com soquete tipo original	LED24V	Acrílica	Amarelo	2052119 / 2080828	02

REPOSIÇÃO	DESCRIÇÃO	EMB.
PL9998.17.97	Chicote com conector 2 vias para lanternas LED	10

PL 0614

Lanterna traseira
Aplicação SC (a partir de 89)



PL0614.01.09 - Sem vigia - LD

PL0614.02.09 - Com vigia - LE



Vista parte traseira



CÓDIGO	DESCRIÇÃO	LADO	COR	REF. ORIGINAL	EMB.
PL0614.01.09	Sem vigia	Direito	Tricolor	527064	01
PL0614.02.09	Com vigia	Esquerdo	Tricolor	527065	01

PL 1614

Lanterna traseira
Aplicação SC Série 4



PL1614.01.09 - Sem vigia - LD

PL1614.02.09 - Com vigia - LE

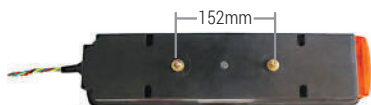

Vista parte traseira



PL1615.00.09

CÓDIGO	DESCRIÇÃO	LADO	COR	REF. ORIGINAL	EMB.
PL1614.01.09	Sem vigia	Direito	Tricolor	1387878 ou 1436868	03
PL1614.02.09	Com vigia	Esquerdo	Tricolor	1387877 ou 1436867	03

CÓDIGO	DESCRIÇÃO	COR	REF. ORIGINAL	EMB.
PL1615.00.09	Lente para lanterna PL1614	Tricolor	1380819	15

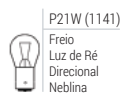

Com cabos.
Fácil instalação.



PL0614.49.09 - Sem vigia - LD

PL0614.50.09 - Com vigia - LE



Vista parte traseira

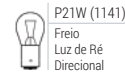

CÓDIGO	DESCRIÇÃO	LADO	COR	EMB.
PL0614.49.09	Com cabos - Sem vigia	Direito	Tricolor	01
PL0614.50.09	Com cabos - Com vigia	Esquerdo	Tricolor	01

PL0615.01.09

PL0615.02.09

CÓDIGO	DESCRIÇÃO	LADO	COR	REF. ORIGINAL	EMB.
PL0615.01.09	Lente sem vigia para PL0614	Direito	Tricolor	1670292	05
PL0615.02.09	Lente com vigia para PL0614	Esquerdo	Tricolor	1670289	05



SC NTG



PL 1442

Lanterna traseira LED com conector tipo original
Aplicação SC

LED 24V



PL1442.01.67 - Sem vigia - LD
PL1442.02.67 - Com vigia - LE



PL1443.01.67 - LD
PL1443.02.67 - LE



CÓDIGO	DESCRIÇÃO	TENSÃO	LENTE	LADO	COR	REF. ORIGINAL	EMB.
PL1442.01.67	Sem vigia	LED 24V	Acrílica	Direito	Bicolor	1905043	01
PL1442.02.67	Com vigia	LED 24V	Acrílica	Esquerdo	Bicolor	1905044	01
REPOSIÇÃO	DESCRIÇÃO	LENTE	LADO	COR	REF. ORIGINAL	EMB.	
PL1443.01.67	Lente para PL1442	Acrílica	Direito	Bicolor	2027555	02	
PL1443.02.67	Lente para PL1442	Acrílica	Esquerdo	Bicolor	2027556	02	
PL1443.00.00	Kit com 6 grampos especiais para fixação da lente PL1443					06	
PL9947.39.00	Chicote 7 vias fêmea com 20cm de cabos					10	

PL 1616 LED

Lanterna traseira LED com conector tipo original
Aplicação SC

LED BIVOLT



PL1616.21.47 - Sem vigia - LD
PL1616.22.47 - Com vigia - LE



CÓDIGO	DESCRIÇÃO	TENSÃO	LADO	COR	EMB.
PL1616.21.47	Com 36 LEDs - Sem vigia	LED BIVOLT	Direito	Bicolor	01
PL1616.22.47	Com 38 LEDs - Com vigia	LED BIVOLT	Esquerdo	Bicolor	01
REPOSIÇÃO	DESCRIÇÃO	EMB.			
PL9947.39.00	Chicote 7 vias fêmea com 20cm de cabos	10			

PL 1616

Lanterna traseira
Aplicação SC



PL1616.41.07 - Sem vigia - LD
PL1616.42.07 - Com vigia - LE

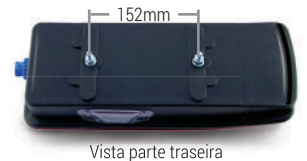

- P21W (1141)
Freio
Luz de Ré
Direcional
Nebolina
- R5W (67)
Posição

CÓDIGO	DESCRIÇÃO	LADO	COR	REF. ORIGINAL	EMB.
PL1616.41.07	Com conector - Sem vigia	Direito	Bicolor	2021575 ou 1756751	01
PL1616.42.07	Com conector - Com vigia	Esquerdo	Bicolor	2021579 ou 1756754	01
REPOSIÇÃO	DESCRIÇÃO	EMB.			
PL9947.39.00	Chicote 7 vias fêmea com 20cm de cabos	10			



PL1616.01.07 - Sem vigia - LD
PL1616.02.07 - Com vigia - LE

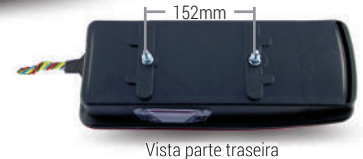

- P21W (1141)
Freio
Luz de Ré
Direcional
Nebolina
- R5W (67)
Posição

CÓDIGO	DESCRIÇÃO	LADO	COR	EMB.
PL1616.01.07	Com cabos para adaptação - Sem vigia	Direito	Bicolor	01
PL1616.02.07	Com cabos para adaptação - Com vigia	Esquerdo	Bicolor	01



PL1617.01.07 - Lado direito
PL1617.02.07 - Lado esquerdo

CÓDIGO	DESCRIÇÃO	LADO	COR	REF. ORIGINAL	EMB.
PL1617.01.07	Lente para lanterna PL1616	Direito	Bicolor	1784670	10
PL1617.02.07	Lente para lanterna PL1616	Esquerdo	Bicolor	1784669	10





VW CONSTELLATION



PL7000



PL0270

Soquete disponível

PL9913



PL0986

Soquete disponível

PL9928

PL9930



PL6050

Chicote disponível

PL9996



PL0896

Soquete disponível

PL9924

PL9926

Chicote disponível

PL9996



PL0898

Chicote disponível

PL9946



PL0482

Chicote disponível

PL9983

PL9985

PL 7000

Farol principal

Aplicação caminhões VW Constellation



PL7000.01.22 - LD
PL7000.02.22 - LE



Vista parte traseira



PL7001.01.22 - LD
PL7001.02.22 - LE



H4
Farol

Não acompanha lâmpada

CÓDIGO	DESCRIÇÃO
PL7000.01.22	Farol principal com guarda pó
PL7000.02.22	Farol principal com guarda pó
REPOSIÇÃO	DESCRIÇÃO
PL7001.01.22	Módulo óptico Farol
PL7001.02.22	Módulo óptico Farol

LADO	COR	REF. ORIGINAL	EMB.
Direito	Cristal	2R2941032	01
Esquerdo	Cristal	2R2941031	01
LADO	COR	EMB.	
Direito	Cristal	01	
Esquerdo	Cristal	01	

PL 7018

Farol duplo com moldura prata

Aplicação caminhões VW Titan 2000 a 2002



PL7003.01.22 - LD
PL7003.02.22 - LE



Vista parte traseira



PL7019.00.19



H1
Farol

Não acompanha lâmpada

CÓDIGO	DESCRIÇÃO	LADO	COR	REF. ORIGINAL	EMB.
PL7018.01.22	Farol duplo moldura prata	Direito	Cristal	2RG941008374	01
PL7018.02.22	Farol duplo moldura prata	Esquerdo	Cristal	2RG941007374	01
REPOSIÇÃO	DESCRIÇÃO	LADO	COR	EMB.	
PL7003.01.22	Módulo óptico Farol	Direito	Cristal	01	
PL7003.02.22	Módulo óptico Farol	Esquerdo	Cristal	01	
PL7019.00.19	Máscara prata para farol PL7018	-	Prata	01	

PL 7022

Farol Luz Alta e baixa

Aplicação caminhões VW Delivery



PL7022.01.22 - LD
PL7022.02.22 - LE



PL7023.01.22 - LD
PL7023.02.22 - LE



H4
Farol

Não acompanha lâmpada

CÓDIGO	DESCRIÇÃO
PL7022.01.22	Farol luz alta e baixa
PL7022.02.22	Farol luz alta e baixa
REPOSIÇÃO	DESCRIÇÃO
PL7023.01.22	Módulo óptico
PL7023.02.22	Módulo óptico

LADO	COR	REF. ORIGINAL	EMB.
Direito	Cristal	2PQ.941.008	01
Esquerdo	Cristal	2PQ.941.007	01
LADO	COR	REF. ORIGINAL	EMB.
Direito	Cristal	EC45 13005	01
Esquerdo	Cristal	EC45 13006	01



PL7003.01.22 - LD
PL7003.02.22 - LE



Vista parte traseira



PL7021.00.17



H1
Farol

Não acompanha lâmpada

CÓDIGO	DESCRIÇÃO	LADO	COR	REF. ORIGINAL	EMB.
PL7020.01.22	Farol duplo moldura preta	Direito	Cristal	2S0941008B41	01
PL7020.02.22	Farol duplo moldura preta	Esquerdo	Cristal	2S0941007B41	01
REPOSIÇÃO	DESCRIÇÃO	LADO	COR	EMB.	
PL7003.01.22	Módulo óptico Farol	Direito	Cristal	01	
PL7003.02.22	Módulo óptico Farol	Esquerdo	Cristal	01	
PL7021.00.17	Máscara preta para farol PL7020	-	Preta	01	



VW WORKER



PL 6026
Farol auxiliar de neblina
Aplicação caminhões MAN TGX



PL6026.01.02 - Lado direito
PL6026.02.02 - Lado esquerdo



PL6027.01.22 - Lado direito
PL6027.02.22 - Lado esquerdo

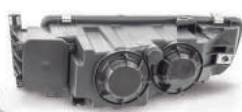

Conector tipo original

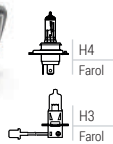

Não acompanha lâmpada

CÓDIGO	DESCRIÇÃO	LADO	COR	REF. ORIGINAL	EMB.
PL6026.01.02	Farol auxiliar de neblina	Direito	Cristal	81251016522 2V5941064	01
PL6026.02.02	Farol auxiliar de neblina	Esquerdo	Cristal	81251016521 2V5941063	01
REPOSIÇÃO	DESCRIÇÃO	LADO	COR	EMB.	
PL6027.01.22	Lente em vidro para PL6027	Direito	Cristal	01	
PL6027.02.22	Lente em vidro para PL6027	Esquerdo	Cristal	01	

PL 6040
Farol principal
Aplicação MAN TGX



PL6040.01.22 - Lado direito
PL6040.02.22 - Lado esquerdo



PL6041.01.22 - Lado direito
PL6041.02.22 - Lado esquerdo

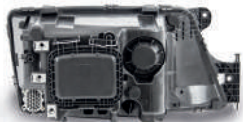

Conector tipo original

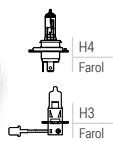

Não acompanha lâmpada

CÓDIGO	DESCRIÇÃO	LADO	COR	EMB.
PL6040.01.02	Farol principal	Direito	Cristal	01
PL6040.02.02	Farol principal	Esquerdo	Cristal	01
REPOSIÇÃO	DESCRIÇÃO	LADO	COR	EMB.
PL6041.01.22	Lente em vidro para PL6040	Direito	Cristal	01
PL6041.02.22	Lente em visro para PL6040	Esquerdo	Cristal	01

PL 6050
Farol auxiliar LED
Aplicação VW Constellation



LED 24V
112mm



Conector tipo original



PL9996.17.97

CÓDIGO	DESCRIÇÃO	TENSÃO	LENTE	COR	REF. ORIGINAL	EMB.
PL6050.24.62	Com conector	LED 24V	Acrílica	Cristal	2T294/063	01
CÓDIGO	DESCRIÇÃO					EMB.
PL9996.17.97	Chicote com conector 2 vias para luz de posição					10

PL 0986
Lanterna direcional
Aplicação VW Constellation



Com kit de fixação



W5W
Posição



PY21W (1056)
Direcional

CÓDIGO	DESCRIÇÃO	LADO	COR	REF. ORIGINAL	EMB.
PL0986.01.02	Sem soquete	Bilateral	Cristal	2R2949102A 2R2949101A	08



Com kit de fixação



W5W
Posição



PY21W (1056)
Direcional

CÓDIGO	DESCRIÇÃO	LADO	COR	EMB.
PL0986.41.02	Com soquete	Bilateral	Cristal	01
CÓDIGO	DESCRIÇÃO	REF. ORIGINAL	EMB.	
PL9928.17.97	Soquete em nylon tipo VW para posição	GM 90 443 393	20	
PL9930.17.97	Soquete em nylon tipo VW para direcional	-	10	



VW DELIVERY



PL7022



PL0554



PL0534



PL0598

Chicote disponível

Soquete disponível



PL9994



PL9914



PL0696



PL9906

Chicote disponível



PL0440

PL 0896

Lanterna direcional
Aplicação VW Constellation



PL0896.24.61



PL0896.24.62

LED 24V



Vista parte lateral

COM LED AMARELO

CÓDIGO	DESCRIÇÃO	TENSÃO	LENTE	COR	EMB.
PL0896.24.61	Com fios para adaptação	LED 24V	Acrílica	Amarelo	05
PL0896.24.62	Com fios para adaptação	LED 24V	Acrílica	Cristal	05



PL0896.00.01

PL0896.00.21 - Acrílica



PL0896.00.02

PL0896.00.22 - Acrílica



W5W
Posição



P21W (1141)
Direcional



PY21W (1056)
Direcional

CÓDIGO	DESCRIÇÃO	LENTE	COR	REF. ORIGINAL	EMB.
PL0896.00.01	Sem soquete	-	Amarelo	2R2 953 037	05
PL0896.00.02	Sem soquete	-	Cristal	-	05
PL0896.00.21	Sem soquete	Acrílica	Amarelo	2R2 953 037	05
PL0896.00.22	Sem soquete	Acrílica	Cristal	-	05



PL0896.41.01

PL0896.41.21 - Acrílica



PL0896.41.02

PL9924.17.96

PL9996.17.97

PL9926.17.94

PL9946.17.00

CÓDIGO	DESCRIÇÃO	LENTE	COR	EMB.
PL0896.41.01	Com soquete	-	Amarelo	05
PL0896.41.02	Com soquete	-	Cristal	05
PL0896.41.21	Com soquete	Acrílica	Amarelo	05

CÓDIGO	DESCRIÇÃO	REF. ORIGINAL	EMB.
PL9924.17.96	Soquete em nylon tipo VW para posição	VW 547 953 055-0	20
PL9926.17.94	Soquete em nylon tipo VW para direcional	GM 90 444 711	10
PL9996.17.97	Chicote com conector 2 vias para luz de posição	-	10
PL9946.17.00	Chicote universal com conector ultra seal 2 vias	-	10

PL 0598

Lanterna direcional
Aplicação VW e universal



PL0598.00.61



PL0598.00.62

LED BIVOLT



Vista parte traseira

CÓDIGO	DESCRIÇÃO	TENSÃO	COR	EMB.
PL0598.00.61	Com fios para adaptação	LED BIVOLT	Amarelo	10
PL0598.00.62	Com fios para adaptação	LED BIVOLT	Cristal	10

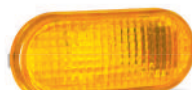

PL0598.00.21



PL0598.00.22



Vista parte traseira

CÓDIGO	DESCRIÇÃO	LENTE	COR	REF. ORIGINAL	EMB.
PL0598.00.21	Sem soquete	Acrílica	Amarelo	W3A 0491 01A	10
PL0598.00.22	Sem soquete	Acrílica	Cristal	-	10

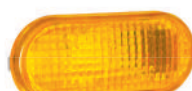

PL0598.41.21



PL0598.41.22



Vista parte traseira

CÓDIGO	DESCRIÇÃO	LENTE	COR	EMB.
PL0598.41.21	Com soquete	Acrílica	Amarelo	10
PL0598.41.22	Com soquete	Acrílica	Cristal	10



PL0598.41.21

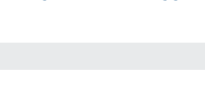

PL0598.41.22



Vista parte traseira

CÓDIGO	DESCRIÇÃO	LENTE	COR	EMB.
PL9994.17.97	Chicote com conector 2 vias tipo MB	-	-	10
PL9914.17.96	Soquete com 1 polo universal e VW	-	-	20

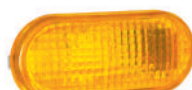

PL0598.13.21



PL0598.13.22



Vista parte traseira

CÓDIGO	DESCRIÇÃO	LENTE	COR	EMB.
PL0598.13.21	Com soquete tipo adaptação	Acrílica	Amarelo	10
PL0598.13.22	Com soquete tipo adaptação	Acrílica	Cristal	10

REPOSIÇÃO	DESCRIÇÃO	REF. ORIGINAL	EMB.
PL9913.17.97	Soquete com 1 polo universal	MB 345.544.01.93 - VL 344-130	20



VW TITAN



PL 0534

Lanterna direcional
Aplicação VW

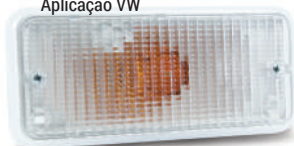

PL0534.03.02



PL0534.00.01



R5W (67)
Posição



PL0535.00.02



PL0535.00.01

**NOVO ENCAIXE PARA
TODOS OS MODELOS**



Suporte metálico não disponível

CÓDIGO	DESCRIÇÃO	COR	REF. ORIGINAL	EMB.
PL0534.03.02	Lanterna direcional com cúpula	Cristal	TAC 953 041	10
PL0534.00.01	Lanterna direcional	Amarelo		10
REPOSIÇÃO	DESCRIÇÃO	COR	REF. ORIGINAL	EMB.
PL0535.00.02	Lente para lanterna PL0534	Cristal	2TA 953 161	10
PL0535.00.01	Lente para lanterna PL0534	Amarelo	T12 953 141	10

PL 0530

Lanterna delimitadora LED
Aplicação caminhões MAN



LED24V

CÓDIGO	DESCRIÇÃO	TENSÃO	LENTE	COR	REF. ORIGINAL	EMB.
PL0530.24.61	Com conector	LED24V	Acrílica	Amarelo	81.2560.6104	01

PL 0890

Lanterna direcional
Aplicação MAN



P21W (1141)
Direcional

CÓDIGO	DESCRIÇÃO	LENTE	COR	REF. ORIGINAL	EMB.
PL0890.00.22	Lanterna direcional	Acrílica	Cristal	81.25320.6116	10

PL 0996

Lanterna direcional e delimitadora LED
Aplicação Delivery e Meteor



PL0996.12.61 - 12V Delivery
PL0996.24.61 - 24V Meteor



Vista parte traseira



PL9997.37.97

CÓDIGO	DESCRIÇÃO	TENSÃO	LENTE	COR	REF. ORIGINAL	EMB.
PL0996.12.61	Com conector	LED 12V	Acrílica	Amarelo	21P953037	04
PL0996.24.61	Com conector	LED 24V	Acrílica	Amarelo	2S2953037	04
REPOSIÇÃO	DESCRIÇÃO					EMB.
PL9997.37.97	Chicote com conector ultra seal 3 vias					10

PL 0572

Lanterna delimitadora
Aplicação ônibus e caminhões VW



PL0572.41.01



Vista parte traseira



R5W (67)
Posição

CÓDIGO	DESCRIÇÃO	COR	REF. ORIGINAL	EMB.
PL0572.41.01	Com soquete para adaptação	Amarelo	1A8 508 910 6	10



PL0572.00.01



PL0573.00.01



Vista parte traseira



R5W (67)
Posição

CÓDIGO	DESCRIÇÃO	COR	REF. ORIGINAL	EMB.
PL0572.00.01	Sem soquete tipo original	Amarelo		10
REPOSIÇÃO	DESCRIÇÃO	COR	REF. ORIGINAL	EMB.
PL0573.00.01	Lente para lanterna PL0572	Amarelo	TAC 949 101	20



VW DELIVERY



PL 0270

Lanterna delimitadora com parafusos embutidos na base
Aplicação caminhões Ford / VW

LED BIVOLT



PL0270.00.02



PL0270.00.42



PL9913.17.97



T4W (69)
Posição

CÓDIGO	DESCRIÇÃO	TENSÃO	COR	REF. ORIGINAL	EMB.
PL0270.00.02	Sem soquete	-	Cristal	2R2 945 341 A1	20
PL0270.00.42			Cristal	-	10
REPOSIÇÃO	DESCRIÇÃO	REF. ORIGINAL		EMB.	
PL9913.17.97	Soquete com 1 polo universal	MB 345.544.01.93 - VL 344-130			20

PL 0470

Conjunto óptico
para lanternas delimitadoras PL0442 e PL0462



CÓDIGO	DESCRIÇÃO	COR	REF. ORIGINAL	EMB.
PL0470.00.02	Sem soquete	Cristal	154 4287 TU	20



CÓDIGO	DESCRIÇÃO	COR	REF. ORIGINAL	EMB.
PL0470.41.02	Com soquete	Cristal	2R2945341A1	20
REPOSIÇÃO	DESCRIÇÃO	REF. ORIGINAL		EMB.
PL9913.17.97	Soquete com 1 polo universal	MB 345.544.01.93 - VL 344-130		20



CÓDIGO	DESCRIÇÃO	TENSÃO	COR	EMB.
PL0470.00.42	Conjunto óptico LED	LED BIVOLT	Cristal	05

PL 0442

Lanterna delimitadora
Aplicação caminhões VW

LED BIVOLT



PL0442.00.02



PL9913.17.97



PL0442.00.42



Vista parte frontal



Vista parte lateral



Vista parte traseira



T4W (69)
Posição

CÓDIGO	DESCRIÇÃO	TENSÃO	COR	REF. ORIGINAL	EMB.
PL0442.00.02	Sem soquete	-	Cristal	2SS945051 ou 2TA945051B	10
PL0442.00.42			LED BIVOLT	Cristal	-
REPOSIÇÃO	DESCRIÇÃO	REF. ORIGINAL		EMB.	
PL9913.17.97	Soquete com 1 polo universal	MB 345.544.01.93 - VL 344-130			20

PL 0554

Lanterna delimitadora
Aplicação ônibus e caminhões VW



PL0554.00.02



PL0554.00.01



PL0555.00.02



R5W (67)
Posição

CÓDIGO	DESCRIÇÃO	COR	REF. ORIGINAL	EMB.
PL0554.00.02	Lanterna delimitadora	Cristal	2TA 945 05 1B	15
PL0554.00.01	Lanterna delimitadora	Amarelo	-	15
REPOSIÇÃO	DESCRIÇÃO	REF. ORIGINAL	EMB.	
PL0555.00.02	Lente para lanterna PL0554	Cristal	2TA 945 425	15

PL 0898

Lanterna delimitadora LED
Aplicação VW Constellation 25.390/ 26.390

LED 24V



PL0898.11.61



PL0898.11.62



Vista parte traseira



PL9946.17.00

CÓDIGO	DESCRIÇÃO	TENSÃO	LENTE	COR	REF. ORIGINAL	EMB.
PL0898.11.61	Com conector	LED 24V	Acrílica	Amarelo	2V29491018	04
PL0898.11.62	Com conector	LED 24V	Acrílica	Cristal	-	04
REPOSIÇÃO	DESCRIÇÃO				EMB.	
PL9946.17.00	Chicote universal com conector ultra seal 2 vias					10



VW METEOR

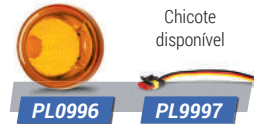

PL 0696
Lanterna delimitadora
Aplicação caminhões VW



PL0696.01.01 - Lado direito
PL0696.02.01 - Lado esquerdo

PL0696.01.02 - Lado direito
PL0696.02.02 - Lado esquerdo



CÓDIGO	DESCRIÇÃO	LADO	COR	REF. ORIGINAL	EMB.
PL0696.01.01	Sem soquete	Direito	Amarelo	T12945362 ou 945 366	10
PL0696.02.01	Sem soquete	Esquerdo	Amarelo	T12945361 ou 945 365	10
PL0696.01.02	Sem soquete	Direito	Cristal	-	10
PL0696.02.02	Sem soquete	Esquerdo	Cristal	-	10



PL0696.21.01 - Lado direito
PL0696.22.01 - Lado esquerdo

Vista parte traseira



CÓDIGO	DESCRIÇÃO	LADO	COR	EMB.
PL0696.21.01	Sem soquete com parafusos	Direito	Amarelo	10
PL0696.22.01	Sem soquete com parafusos	Esquerdo	Amarelo	10



PL0696.41.01 - Lado direito
PL0696.42.01 - Lado esquerdo

Vista parte traseira



CÓDIGO	DESCRIÇÃO	LADO	COR	EMB.
PL0696.41.01	Com soquete e parafusos	Direito	Amarelo	10
PL0696.42.01	Com soquete e parafusos	Esquerdo	Amarelo	10
PL9906.17.00	Chicote com soquete de 1 polo tipo VW			10

PL 0547
Refletivo dianteiro auto-adesivo
Aplicação VW 23.210 e outros



PL0547.01.01 - Lado direito
PL0547.02.01 - Lado esquerdo

CÓDIGO	DESCRIÇÃO	LADO	COR	REF. ORIGINAL	EMB.
PL0547.01.01	Refletivo dianteiro	Direito	Amarelo	2S0 945106	20
PL0547.02.01	Refletivo dianteiro	Esquerdo	Amarelo	2S0 945105	20

PL 0698
Lanterna delimitadora
Aplicação caminhões VW

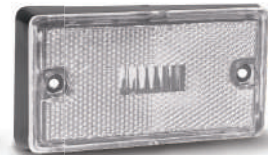
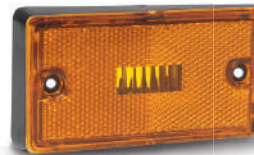

PL0698.00.01

PL0698.00.02



CÓDIGO	DESCRIÇÃO	COR	REF. ORIGINAL	EMB.
PL0698.00.01	Sem soquete	Amarelo	T12945362 ou 945 366	10
PL0698.00.02	Sem soquete	Cristal	-	10



PL0698.21.01



CÓDIGO	DESCRIÇÃO	COR	REF. ORIGINAL	EMB.
PL0698.21.01	Sem soquete com parafusos	Amarelo	945 365	10



PL0698.41.01



PL9906.17.00



CÓDIGO	DESCRIÇÃO	COR	EMB.
PL0698.41.01	Com soquete e parafusos	Amarelo	10
REPOSIÇÃO	DESCRIÇÃO		EMB.
PL9906.17.00	Chicote com soquete de 1 polo tipo VW		10

PL 1622
Lanterna delimitadora LED
Aplicação caminhões MAN



PL1622.41.62



CÓDIGO	DESCRIÇÃO	TENSÃO	LENTE	COR	REF. ORIGINAL	EMB.
PL1622.41.62	Com conector	LED BIVOLT	Acrílica	Cristal	81.2526.06121	05



MAN TGX



PL1622



PL6026



PL6027



PL6040



PL6041



PL0530



PL0890



PL1618



Chicote disponível

PL9947

PL 0440 LED

Lanterna traseira LED para caminhões Ford / VW



LED BIVOLT



PL0441.00.09

Lanterna traseira com lente lisa



LED BIVOLT



PL0441.23.09

CÓDIGO	DESCRIÇÃO	TENSÃO	LADO	COR	EMB.
PL0440.21.49	Com 22 LEDs - Sem vigia	LED BIVOLT	Direito	Tricolor	06
PL0440.22.49	Com 24 LEDs - Com vigia	LED BIVOLT	Esquerdo	Tricolor	06
REPOSIÇÃO	DESCRIÇÃO	COR	REF. ORIGINAL	EMB.	
PL0441.00.09	Lente para lanterna PL0440	Tricolor	T12 945 223 A	30	

CÓDIGO	DESCRIÇÃO	TENSÃO	LADO	COR	EMB.
PL0440.23.49	Com 22 LEDs e lente lisa - Sem vigia	LED BIVOLT	Direito	Tricolor	06
PL0440.24.49	Com 24 LEDs e lente lisa - Com vigia	LED BIVOLT	Esquerdo	Tricolor	06
REPOSIÇÃO	DESCRIÇÃO	COR	EMB.		
PL0441.23.09	Lente lisa para lanterna PL0440	Tricolor	30		

PL 0440

Lanterna traseira para caminhões Ford / VW (VW de 89 a 2011)



PL0441.00.09



P21W (1141)
Luz de ré Direcional



P21/5W (1034)
Freio e Posição

Lanterna traseira com lente lisa



PL0441.23.09



P21W (1141)
Luz de ré Direcional



P21/5W (1034)
Freio e Posição

CÓDIGO	DESCRIÇÃO	LADO	COR	REF. ORIGINAL	EMB.
PL0440.01.09	Sem vigia	Direito	Tricolor	Ford 98HU13404AA - VW T12 945 096	06
PL0440.02.09	Com vigia	Esquerdo	Tricolor	Ford 98HU13405AA - VW T12 945 095	06
REPOSIÇÃO	DESCRIÇÃO	COR	REF. ORIGINAL	EMB.	
PL0441.00.09	Lente para lanterna PL0440	Tricolor	T12 945 223 A	30	

CÓDIGO	DESCRIÇÃO	LADO	COR	EMB.
PL0440.23.09	Com lente lisa - Sem vigia	Direito	Tricolor	06
PL0440.24.09	Com lente lisa - Com vigia	Esquerdo	Tricolor	06
REPOSIÇÃO	DESCRIÇÃO	COR	EMB.	
PL0441.23.09	Lente lisa para lanterna PL0440	Tricolor	30	

Lanterna traseira com lente em acrílico



PL0441.00.29



P21W (1141)
Luz de ré Direcional



P21/5W (1034)
Freio e Posição

Lanterna traseira com lente bicolor



PL0441.00.07



P21W (1141)
Luz de ré



P21/5W (1034)
Freio e Posição



PY21W (1056)
Direcional

CÓDIGO	DESCRIÇÃO	Lente	LADO	COR	EMB.
PL0440.01.29	Sem vigia	Acrílica	Direito	Tricolor	06
PL0440.02.29	Com vigia	Acrílica	Esquerdo	Tricolor	06
REPOSIÇÃO	DESCRIÇÃO	LENTE	COR	EMB.	
PL0441.00.29	Lente para lanterna PL0440	Acrílica	Tricolor	30	

CÓDIGO	DESCRIÇÃO	LADO	COR	EMB.
PL0440.01.07	Sem vigia	Direito	Bicolor	06
PL0440.02.07	Com vigia	Esquerdo	Bicolor	06
REPOSIÇÃO	DESCRIÇÃO	COR	EMB.	
PL0441.00.07	Lente lanterna PL0440	Bicolor	30	



PL 0482 LED

Lanterna traseira LED com lente bolha / bojudá



CÓDIGO	DESCRIÇÃO	TENSÃO	LADO	COR	EMB.
PL0482.21.47	Com 20 LEDs - Sem vigia	LED BIVOLT	Direito	Bicolor	06
PL0482.22.47	Com 22 LEDs - Com vigia	LED BIVOLT	Esquerdo	Bicolor	06
REPOSIÇÃO	DESCRIÇÃO		COR		EMB.
PL0483.21.07	Lente para lanterna PL0482			Vermelho e cristal	30

* Produto não original - desenho exclusivo com bolha

PL 0482

Lanterna traseira com lente bolha / bojudá



CÓDIGO	DESCRIÇÃO	LADO	COR	REF. ORIGINAL	EMB.
PL0482.21.07	Sem vigia	Direito	Bicolor	2S945096 ou 2R0945096E	06
PL0482.22.07	Com vigia	Esquerdo	Bicolor	2S945095 ou 2R0945095H	06
REPOSIÇÃO	DESCRIÇÃO		COR	REF. ORIGINAL	EMB.
PL0483.21.07	Lente para lanterna PL0482		Bicolor	2R0945223A	30
PL9983.00.00	Chicote conector 6 vias - Macho				10
PL9985.00.00	Chicote conector 6 vias - Fêmea				10

* Produto não original - desenho exclusivo com bolha

Com cabos.
Fácil instalação.



CÓDIGO	DESCRIÇÃO	LADO	COR	REF. ORIGINAL	EMB.
PL0482.49.07	Com cabos - Sem vigia	Direito	Bicolor	2S945096 ou 2R0945096E	06
PL0482.50.07	Com cabos - Com vigia	Esquerdo	Bicolor	2S945095 ou 2R0945095H	06
REPOSIÇÃO	DESCRIÇÃO		COR	REF. ORIGINAL	EMB.
PL0483.21.07	Lente para lanterna PL0482		Bicolor	2R0945223A	30

* Produto não original - desenho exclusivo com bolha



CÓDIGO	DESCRIÇÃO	LENTE	LADO	COR	REF. ORIGINAL	EMB.
PL0482.21.27	Sem vigia	Acrílica	Direito	Bicolor	2S2945096	06
PL0482.22.27	Com vigia	Acrílica	Esquerdo	Bicolor	2S2945095	06
REPOSIÇÃO	DESCRIÇÃO		LENTE	COR	REF. ORIGINAL	EMB.
PL0483.21.27	Lente para lanterna PL0482		Acrílica	Bicolor	2R0945223A	30
PL9983.00.00	Chicote conector 6 vias - Macho					10
PL9985.00.00	Chicote conector 6 vias - Fêmea					10

* Produto não original - desenho exclusivo com bolha

PL 1618 LED

Lanterna traseira LED com conector tipo original
Aplicação caminhões MAN



PL1618.21.51 - Sem vigia - LD
PL1618.22.51 - Com vigia - LE



PL9947.39.00

CÓDIGO	DESCRIÇÃO	TENSÃO	LADO	COR	EMB.
PL1618.21.51	Com 36 LEDs - Sem vigia	LED BIVOLT	Direito	Bicolor	01
PL1618.22.51	Com 38 LEDs - Com vigia	LED BIVOLT	Esquerdo	Bicolor	01
REPOSIÇÃO	DESCRIÇÃO				EMB.
PL9947.39.00	Chicote 7 vias fêmea com 20cm de cabos				10

PL 1618

Lanterna traseira
Aplicação caminhões MAN



PL1618.41.11 - Sem vigia - LD
PL1618.42.11 - Com vigia - LE



PL1619.01.11 - Lado direito
PL1619.02.11 - Lado esquerdo



Vista parte traseira



PL9947.39.00

- P21W (1141)
Freio
Luz de Ré
Direcional
Nebulosa
- R5W (67)
Posição

CÓDIGO	DESCRIÇÃO	LADO	COR	REF. ORIGINAL	EMB.
PL1618.41.11	Sem vigia	Direito	Vermelho e azul	2V5945096C	01
PL1618.42.11	Com vigia	Esquerdo	Vermelho e azul	2V5945095B	01
REPOSIÇÃO	DESCRIÇÃO	LADO	COR	REF. ORIGINAL	EMB.
PL1619.01.11	Lente para PL1618	Direito	Vermelho e azul	2V5941112	10
PL1619.02.11	Lente para PL1618	Esquerdo	Vermelho e azul	2V5945111	10
PL9947.39.00	Chicote 7 vias fêmea com 20cm de cabos			-	10



VL FH 4



PL6008



PL6010



PL0744

Chicote disponível

PL9998



PL6022

Chicote disponível

PL9998



PL0728

Chicote disponível

PL9947

PL 6004

Farol auxiliar foco duplo com soquete tipo original
Aplicação caminhões FH13



PL6004.01.02 - Lado direito

PL6004.02.02 - Lado esquerdo



PL6005.01.02 - Lado direito

PL6005.02.02 - Lado esquerdo



PL6005.01.16 - Lado direito

PL6005.02.16 - Lado esquerdo



H1 Farol



H7 Farol

Não acompanha lâmpada

CÓDIGO	DESCRIÇÃO	LADO	COR	REF. ORIGINAL	EMB.
PL6004.01.02	Foco duplo	Direito	Cristal	21297917	01
PL6004.02.02	Foco duplo	Esquerdo	Cristal	21297918	01
REPOSIÇÃO	DESCRIÇÃO	LADO	COR	REF. ORIGINAL	EMB.
PL6005.01.02	Lente em vidro para PL6004	Direito	Cristal	21120482	01
PL6005.02.02	Lente em vidro para PL6004	Esquerdo	Cristal	21118550	01
PL6005.01.16	Moldura para farol auxiliar	Direito	-	-	02
PL6005.02.16	Moldura para farol auxiliar	Esquerdo	-	-	02

PL 6018

Farol principal com pisca, LED luz diurna e soquete tipo original
Aplicação caminhões FH13 FM13 2009/2016



PL6018.01.22 - Lado direito

PL6018.02.22 - Lado esquerdo



PL6019.01.22 - LD

PL6019.02.22 - LE



Conector tipo original



H4 Farol



H7 Farol



PY21W (1056) Direcional

Não acompanha lâmpada

CÓDIGO	DESCRIÇÃO	LENTE	LADO	COR	REF. ORIGINAL	EMB.
PL6018.01.22	Farol principal	Policarbonato	Direito	Cristal	21035637	01
PL6018.02.22	Farol principal	Policarbonato	Esquerdo	Cristal	21035638	01
REPOSIÇÃO	DESCRIÇÃO	LADO	COR	EMB.		
PL6019.01.22	Lente em policarbonato para PL6018	Direito	Cristal	01		
PL6019.02.22	Lente em policarbonato para PL6018	Esquerdo	Cristal	01		

PL 6008

Farol auxiliar foco duplo com soquete tipo original
Aplicação caminhões FH16



PL6008.01.22 - Lado direito

PL6008.02.22 - Lado esquerdo



H1 Farol



H7 Farol

Não acompanha lâmpada

CÓDIGO	DESCRIÇÃO	LENTE	LADO	COR	REF. ORIGINAL	EMB.
PL6008.01.22	Foco duplo	Policarbonato	Direito	Cristal	21221153 - 82140763	01
PL6008.02.22	Foco duplo	Policarbonato	Esquerdo	Cristal	21221154 - 82140744	01



PL6010.01.22 - Lado direito

PL6010.02.22 - Lado esquerdo



H1 Farol



H7 Farol

Não acompanha lâmpada

CÓDIGO	DESCRIÇÃO	LENTE	LADO	COR	REF. ORIGINAL	EMB.
PL6010.01.22	Foco simples	Policarbonato	Direito	Cristal	21221151	01
PL6010.02.22	Foco simples	Policarbonato	Esquerdo	Cristal	21221152	01



VL FH 13



PL 6020

Farol principal com soquete tipo original
Aplicação caminhões VM 2006/2014



PL6020.01.22 - Lado direito
PL6020.02.22 - Lado esquerdo

Conector tipo original

Não acompanha lâmpada

CÓDIGO	DESCRIÇÃO	LENTE	LADO	COR	REF. ORIGINAL	EMB.
PL6020.01.22	Farol principal	Policarbonato	Direito	Cristal	20818771	01
PL6020.02.22	Farol principal	Policarbonato	Esquerdo	Cristal	20818763	01

PL 6022

Farol principal com LED luz diurna e soquete tipo original
Aplicação caminhões FH14 FH16



Conector tipo original



PL6022.01.22 - Lado direito
PL6022.02.22 - Lado esquerdo

PL6023.01.22 - LD
PL6023.02.22 - LE

Não acompanha lâmpada

CÓDIGO	DESCRIÇÃO	LENTE	LADO	COR	REF. ORIGINAL	EMB.
PL6022.01.22	Farol principal	Policarbonato	Direito	Cristal	21221129	01
PL6022.02.22	Farol principal	Policarbonato	Esquerdo	Cristal	21221130	01
REPOSIÇÃO	DESCRIÇÃO	LADO	COR	EMB.		
PL6023.01.22	Lente em policarbonato para PL6022	Direito	Cristal	01		
PL6023.02.22	Lente em policarbonato para PL6022	Esquerdo	Cristal	01		

PL 6035

Lente em vidro e Moldura para farol principal
Aplicação farol principal caminhões VL FH12 FM12



PL6035.01.22 - Lado direito
PL6035.02.22 - Lado esquerdo

PL6035.01.16 - Lado direito
PL6035.02.16 - Lado esquerdo

Não acompanha lâmpada

CÓDIGO	DESCRIÇÃO	LADO	COR	REF. ORIGINAL	EMB.
PL6035.01.22	Para farol principal VL FH	Direito	Cristal	-	01
PL6035.02.22	Para farol principal VL FH	Esquerdo	Cristal	-	01
PL6035.01.16	Moldura para farol principal	Direito	-	-	01
PL6035.02.16	Moldura para farol principal	Esquerdo	-	-	01

PL 0708

Lanterna direcional
Aplicação VL VM



PL0708.21.22 - Lado direito
PL0708.22.22 - Lado esquerdo

PL9921.17.97

CÓDIGO	DESCRIÇÃO	LENTE	LADO	COR	REF. ORIGINAL	EMB.
PL0708.21.22	Sem soquete	Acrílica	Direito	Cristal	2053 7295	01
PL0708.22.22	Sem soquete	Acrílica	Esquerdo	Cristal	2053 7294	01
REPOSIÇÃO	DESCRIÇÃO					EMB.
PL9921.17.97	Soquete em nylon tipo VL					10



VL FH



PL6035



PL0752



PL1704

Soquete disponível

PL9920



PL0728

Chicote disponível

PL9947

PL 0700

Lanterna direcional
Aplicação VL NL 10 / 12



PL0700.01.06 - Lado direito
PL0700.02.06 - Lado esquerdo



PL0701.01.06 - LD
PL0701.02.06 - LE



P21W (1141)
Direcional
Posição

CÓDIGO	LADO	COR	REF. ORIGINAL	EMB.	
PL0700.01.06	Direito	Amarelo e cristal	V08121102 ou 812 1102	04	
PL0700.02.06	Esquerdo	Amarelo e cristal	V08121103 ou 812 1103	04	
CÓDIGO	DESCRIÇÃO	LADO	COR	REF. ORIGINAL	EMB.
PL0701.01.06	Lente para PL0700	Direito	Amarelo e cristal	9003 ou 130 7454	05
PL0701.02.06	Lente para PL0700	Esquerdo	Amarelo e cristal	9002 ou 13 7453	05

PL 1700

Lanterna direcional
Aplicação VL NH - 12



PL1700.01.01 - LD
PL1700.02.01 - LE



P21W (1141)
Direcional

CÓDIGO	DESCRIÇÃO	LADO	COR	REF. ORIGINAL	EMB.
PL1700.01.01	Lanterna direcional	Direito	Amarelo	8 129 383	02
PL1700.02.01	Lanterna direcional	Esquerdo	Amarelo	8 129 384	02



PL1700.03.02 - LD
PL1700.04.02 - LE



P21W (1141)
Direcional

CÓDIGO	DESCRIÇÃO	LADO	COR	REF. ORIGINAL	EMB.
PL1700.03.02	Com cúpula	Direito	Cristal	205 21 163	02
PL1700.04.02	Com cúpula	Esquerdo	Cristal	205 21 164	02

PL 0740

Lanterna direcional
Aplicação VM220, VM270 e VM330



PL0740.00.21



PL0740.00.22



PL9932.17.94



R5W (67)
Posição

CÓDIGO	DESCRIÇÃO	LENTE	COR	REF. ORIGINAL	EMB.
PL0740.00.21	Lanterna direcional	Acrílica	Amarelo	21341202	10
PL0740.00.22	Lanterna direcional	Acrílica	Cristal	-	10
REPOSIÇÃO	DESCRIÇÃO	EMB.			
PL9932.17.94	Soquete com 1 polo em nylon tipo VL	10			

PL 0714

Lanterna direcional 12 LEDs
Aplicação VL e universal*

LED24V

COM LED
AMARELO



PL0714.21.62 - Lado direito
PL0714.22.62 - Lado esquerdo



Conector tipo original



PL9998.17.97

Chicote disponível

* Produto não original - desenho modificado.

CÓDIGO	DESCRIÇÃO	TENSÃO	LENTE	LADO	COR	REF. ORIGINAL	EMB.
PL0714.21.62	Com conector	LED24V	Acrílica	Direito	Cristal	82355678	08
PL0714.22.62	Com conector	LED24V	Acrílica	Esquerdo	Cristal	82114500	08
REPOSIÇÃO	DESCRIÇÃO	EMB.					
PL9998.17.97	Chicote com conector 2 vias para lanternas LED	10					



VL FH 12



PL 1708

Lanterna direcional com cúpula
Aplicação FH 12 (96 a 2004)



PL1708.00.22



CÓDIGO	DESCRIÇÃO	LENTE	COR	REF. ORIGINAL	EMB.
PL1708.00.22	Sem soquete	Acrílica	Cristal	398 1668	02



PL1708.13.22



CÓDIGO	DESCRIÇÃO	LENTE	COR	EMB.
PL1708.13.22	Com soquete	Acrílica	Cristal	02
PL9919.37.94	Soquete com 2 polos em nylon tipo VL			10

PL 0744

Lanterna direcional LED
Aplicação VL FH



PL0744.33.62 - Lado direito
PL0744.34.62 - Lado esquerdo

COM LED AMARELO



CÓDIGO	DESCRIÇÃO	TENSÃO	LENTE	LADO	COR	REF. ORIGINAL	EMB.
PL0744.33.62	Com conector	LED24V	Acrílica	Direito	Cristal	82151205	01
PL0744.34.62	Com conector	LED24V	Acrílica	Esquerdo	Cristal	82151157	01
PL9998.17.97	Chicote com conector 2 vias para lanternas LED						10

PL 0704

Lanterna direcional
Aplicação ônibus, caminhões VL e universal



PL0704.00.01



CÓDIGO	DESCRIÇÃO	COR	EMB.
PL0704.00.01	Sem soquete	Amarelo	10



PL0704.41.01



CÓDIGO	DESCRIÇÃO	COR	EMB.
PL0704.41.01	Com luva e soquete	Amarelo	10



PL0704.31.01



CÓDIGO	DESCRIÇÃO	COR	REF. ORIGINAL	EMB.
PL0704.31.01	Com luva, soquete e rabicho	Amarelo	37201043 ou 8121815	10



PL0704.00.41



LED BIVOLT

CÓDIGO	DESCRIÇÃO	TENSÃO	COR	EMB.
PL0704.00.41	Com LED	LED BIVOLT	Amarelo	10



PL0705.00.01

REPOSIÇÃO	DESCRIÇÃO	COR	EMB.
PL0705.00.01	Lente para lanterna PL0704	Amarelo	20



VL NH



PL0706

Soquete disponível

PL9911



PL1700



PL0702



PL1702

PL 1704

Lanterna direcional
Aplicação VL FH 12



PL1706.01.17 - Lado direito
PL1706.02.17 - Lado esquerdo

- PL1704.01.01 - Lado direito
- PL1704.02.01 - Lado esquerdo
- PL1704.01.21 - Lente em acrílico - Lado direito
- PL1704.02.21 - Lente em acrílico - Lado esquerdo



CÓDIGO	DESCRIÇÃO	LENTE	LADO	COR	REF. ORIGINAL	EMB.
PL1704.01.01	Sem soquete	PS	Direito	Amarelo	-	10
PL1704.02.01	Sem soquete	PS	Esquerdo	Amarelo	-	10
PL1704.01.21	Sem soquete	Acrílico	Direito	Amarelo	2082 6211 ou 2040 9875	10
PL1704.02.21	Sem soquete	Acrílico	Esquerdo	Amarelo	2082 6213 ou 2040 9874	10
CÓDIGO	DESCRIÇÃO	LADO	REF. ORIGINAL	EMB.		
PL1706.01.17	Suporte em ABS para PL1704	Direito	2082 6231 ou 2042 5419	20		
PL1706.02.17	Suporte em ABS para PL1704	Esquerdo	2082 6227 ou 2042 5418	20		



PL1704.41.01 - Lado direito
PL1704.42.01 - Lado esquerdo



PL1706.01.17 - Lado direito
PL1706.02.17 - Lado esquerdo



CÓDIGO	DESCRIÇÃO	LENTE	LADO	COR	EMB.
PL1704.41.01	Com soquete	PS	Direito	Amarelo	10
PL1704.42.01	Com soquete	PS	Esquerdo	Amarelo	10
CÓDIGO	DESCRIÇÃO	LADO	REF. ORIGINAL	EMB.	
PL1706.01.17	Suporte em ABS para PL1704	Direito	2082 6231 ou 2042 5419	20	
PL1706.02.17	Suporte em ABS para PL1704	Esquerdo	2082 6227 ou 2042 5418	20	
PL9920.17.97	Soquete em nylon tipo VL				20

PL 1710

Lanterna direcional
Aplicação FH 12 (96 a 2004)



PL1710.00.22



Vista parte traseira



CÓDIGO	DESCRIÇÃO	LENTE	COR	REF. ORIGINAL	EMB.
PL1710.00.22	Sem soquete	Acrílico	Cristal	398 1666	02



PL1710.41.22



Vista parte traseira



PL9932.17.94



CÓDIGO	DESCRIÇÃO	LENTE	COR	EMB.
PL1710.41.22	Com soquete	Acrílico	Cristal	02
REPOSIÇÃO	DESCRIÇÃO	EMB.		
PL9932.17.94	Soquete com 1 polo em nylon tipo VL	10		

PL 0746

Lanterna delimitadora LED
Aplicação FH e FM



PL0746.24.61

LED24V

Chicote disponível



PL9998.17.97

CÓDIGO	DESCRIÇÃO	TENSÃO	LENTE	COR	REF. ORIGINAL	EMB.
PL0746.24.61	Com conector	LED24V	Acrílico	Amarelo	20789440	05
REPOSIÇÃO	DESCRIÇÃO	EMB.				
PL9998.17.97	Chicote com conector 2 vias para lanternas LED	10				



VL NL



PL0700



PL0704



PL0702



PL1702

PL 0706

Lanterna delimitadora
Aplicação VL FH / NH - 12



PL0706.00.02

CÓDIGO	DESCRIÇÃO	COR	REF. ORIGINAL	EMB.
PL0706.00.02	Sem soquete	Cristal	8 141 013	06



PL0706.41.02

CÓDIGO	DESCRIÇÃO
PL0706.41.02	Com soquete
REPOSIÇÃO	DESCRIÇÃO
PL9911.17.97	Chicote com soquete de 1 polo tipo ônibus



PL9911.17.97



COR	EMB.
Cristal	06
	EMB.
	10

PL 0710

Lanterna delimitadora
Aplicação VL VM



CÓDIGO	DESCRIÇÃO
PL0710.00.22	Com soquete



Conector tipo original



LENTE	COR	REF. ORIGINAL	EMB.
Acrílica	Cristal	20745225 ou 20495172	02

PL 0486

Lanterna delimitadora LED
Aplicação VL



LED BIVOLT

Chicote disponível



PL9998.17.97

CÓDIGO	DESCRIÇÃO	TENSÃO	LENTE	COR	REF. ORIGINAL	EMB.
PL0486.00.62	Com conector	LED BIVOLT	Acrílica	Cristal	82116545	10
REPOSIÇÃO	DESCRIÇÃO					EMB.
PL9998.17.97	Chicote com conector 2 vias para lanternas LED					10

PL 0752

Lanterna delimitadora para caminhões VL FH



PL0752.15.22



CÓDIGO	DESCRIÇÃO	LENTE	COR	EMB.
PL0752.15.22	Com base reta	Acrílica	Cristal	10



PL0752.35.22



PL0752.36.22



CÓDIGO	DESCRIÇÃO	LENTE	LADO	COR	EMB.
PL0752.35.22	Com base curva	Acrílica	Direito	Cristal	10
PL0752.36.22	Com base curva	Acrílica	Esquerdo	Cristal	10



PL0752.15.62

LED24V

CÓDIGO	DESCRIÇÃO	TENSÃO	LENTE	COR	REF. ORIGINAL	EMB.
PL0752.15.62	Com base reta	LED24V	Acrílica	Cristal	20425016	10



PL0752.35.62



PL0752.36.62

LED24V

CÓDIGO	DESCRIÇÃO	TENSÃO	LENTE	LADO	COR	EMB.
PL0752.35.62	Com base curva	LED24V	Acrílica	Direito	Cristal	10
PL0752.36.62	Com base curva	LED24V	Acrílica	Esquerdo	Cristal	10



PL0753.00.22

CÓDIGO	DESCRIÇÃO	LENTE	COR	EMB.
PL0753.00.22	Lente para lanterna PL0752	Acrílica	Cristal	10



VL VM



PL6020



PL0710



PL0740

Soquete disponível



PL9932



PL1550

Chicote disponível



PL9947

PL 1702

Lanterna traseira

Aplicação VL FH / NH / FM / 12



PL1702.13.09 - Sem vigia - LD

PL1702.14.09 - Com vigia - LE



PL1615.00.09



Vista parte traseira

P21W (1141)



Freio
Luz de Ré
Direcional
Nebulosa

R5W (67)

Posição

CÓDIGO	DESCRIÇÃO	LADO	COR	REF. ORIGINAL	EMB.
PL1702.13.09	Sem vigia	Direito	Tricolor	398 1461 ou 819 1747	03
PL1702.14.09	Com vigia	Esquerdo	Tricolor	398 1460 ou 819 1748	03
REPOSIÇÃO	DESCRIÇÃO		COR		EMB.
PL1615.00.09	Lente para lanterna PL1702		Tricolor		15

PL 0724

Lanterna traseira

Aplicação VL



PL0724.01.09 - Sem vigia - LD

PL0724.02.09 - Com vigia - LE



PL0721.00.09



Vista parte traseira



P21W (1141)
Freio
Luz de Ré
Direcional
Posição
Nebulosa

CÓDIGO	DESCRIÇÃO	LADO	COR	REF. ORIGINAL	EMB.
PL0724.01.09	Com fios sem vigia	Direito	Tricolor	81917444	03
PL0724.02.09	Com fios com vigia	Esquerdo	Tricolor	81917443	03
REPOSIÇÃO	DESCRIÇÃO		COR		EMB.
PL0721.00.09	Lente para lanterna PL0724		Tricolor		15

PL 1550

Lanterna traseira LED

Aplicação VL VM

LED 24V



PL1550.01.47 - LED 24V - Sem vigia

PL1550.02.47 - LED 24V - Com vigia



PL1702.41.09 - Sem vigia - LD

PL1702.42.09 - Com vigia - LE

Conector tipo original



PL1615.00.09



PL9947.39.00

P21W (1141)



Freio
Luz de Ré
Direcional
Nebulosa

R5W (67)

Posição



PL1551.00.07



Conector tipo original



PL9947.39.00

CÓDIGO	DESCRIÇÃO	LADO	COR	EMB.	TENSÃO	LADO	COR	REF. ORIGINAL	EMB.
PL1702.41.09	Com conector - Sem vigia	Direito	Tricolor	01	LED 24V	Direito	Bicolor	84441760	01
PL1702.42.09	Com conector - Com vigia	Esquerdo	Tricolor	01	LED 24V	Esquerdo	Bicolor	82483073	01
REPOSIÇÃO	DESCRIÇÃO		COR				COR	REF. ORIGINAL	EMB.
PL1615.00.09	Lente para lanterna PL1702		Tricolor	15			Bicolor	84122332	06
PL9947.39.00	Chicote 7 vias fêmea com 20cm de cabos			10					10
CÓDIGO	DESCRIÇÃO		COR				COR	REF. ORIGINAL	EMB.
PL1550.01.47	Com conector sem vigia	Direito	Bicolor	01	LED 24V	Direito	Bicolor	84441760	01
PL1550.02.47	Com conector com vigia	Esquerdo	Bicolor	01	LED 24V	Esquerdo	Bicolor	82483073	01
PL1551.00.07	Lente para Lanterna PL1550		Bicolor	06			Bicolor	84122332	06
PL9947.39.00	Chicote 7 vias fêmea com 20cm de cabos			10					10



VL VM



PL 0702

Lanterna traseira
Aplicação VL NL 10 / 12



PL0702.13.09 - Sem vigia - LD
PL0702.14.09 - Com vigia - LE

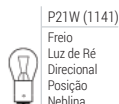

PL0703.00.09



Vista parte traseira

CÓDIGO	DESCRIÇÃO	LADO	COR	REF. ORIGINAL	EMB.
PL0702.13.09	Sem vigia	Direito	Tricolor	01620477	01
PL0702.14.09	Com vigia	Esquerdo	Tricolor	01620476	01
REPOSIÇÃO	DESCRIÇÃO	COR	REF. ORIGINAL	EMB.	
PL0703.00.09	Lente para lanterna PL0702	Tricolor	016204480	15	

PL 0728

Lanterna traseira
Aplicação VL FH



PL0728.41.09 - Sem vigia - LD
PL0728.42.09 - Com vigia - LE

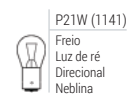

PL0729.00.09



PL9947.39.00



Conector tipo original

CÓDIGO	DESCRIÇÃO	LADO	COR	REF. ORIGINAL	EMB.
PL0728.41.09	Com conector - Sem vigia	Direito	Tricolor	20507624 ou 1508181	01
PL0728.42.09	Com conector - Com vigia	Esquerdo	Tricolor	20507623 ou 1508180	01
CÓDIGO	DESCRIÇÃO	COR	REF. ORIGINAL	EMB.	
PL0729.00.09	Lente para Lanterna PL0728	Tricolor	20425732 ou 1412392	10	
PL9947.39.00	Chicote 7 vias fêmea com 20cm de cabos			10	

PL 0728 LED

Lanterna traseira LED
Aplicação VL FH



PL0728.21.49 - Sem vigia - LD
PL0728.22.49 - Com vigia - LE

LED BIVOLT



PL0729.00.09



PL9947.39.00



Conector tipo original

CÓDIGO	DESCRIÇÃO	TENSÃO	LADO	COR	EMB.
PL0728.21.49	Com 30 LEDs e conector - Sem vigia	LED BIVOLT	Direito	Tricolor	01
PL0728.22.49	Com 32 LEDs e conector - Com vigia	LED BIVOLT	Esquerdo	Tricolor	01
CÓDIGO	DESCRIÇÃO	COR	REF. ORIGINAL	EMB.	
PL0729.00.09	Lente para Lanterna PL0728	Tricolor	20425732 ou 1412392	10	
PL9947.39.00	Chicote 7 vias fêmea com 20cm de cabos			10	



PL0728.13.09 - Sem vigia - LD
PL0728.14.09 - Com vigia - LE

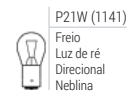

PL0729.00.09



Fios para adaptação

CÓDIGO	DESCRIÇÃO	LADO	COR	EMB.
PL0728.13.09	Com cabos para adaptação - Sem vigia	Direito	Tricolor	01
PL0728.14.09	Com cabos para adaptação - Com vigia	Esquerdo	Tricolor	01
CÓDIGO	DESCRIÇÃO	COR	REF. ORIGINAL	EMB.
PL0729.00.09	Lente para Lanterna PL0728	Tricolor	20425732 ou 1412392	10



ÔNIBUS

PL 0450

Lanterna direcional
Aplicação MB 718 / 912 / 914 e universal



PL0450.00.01



PL0450.00.02



PL0451.00.01



PL0451.00.02



CÓDIGO	DESCRIÇÃO	COR	REF. ORIGINAL	EMB.
PL0450.00.01	Lanterna direcional	Amarelo	688 820 70 56	10
PL0450.00.02	Lanterna direcional	Cristal	-	10
REPOSIÇÃO	DESCRIÇÃO	COR	REF. ORIGINAL	EMB.
PL0451.00.01	Lente para lanterna PL0450	Amarelo	000 820 00 56	20
PL0451.00.02	Lente para lanterna PL0450	Cristal	-	20

PL 0572

Lanterna delimitadora
Aplicação ônibus e caminhões VW



PL0572.41.01



Vista parte traseira



CÓDIGO	DESCRIÇÃO	COR	REF. ORIGINAL	EMB.
PL0572.41.01	Com soquete para adaptação	Amarelo	1A8 508 910 6	10



PL0572.00.01



Vista parte traseira



PL0573.00.01



CÓDIGO	DESCRIÇÃO	COR	REF. ORIGINAL	EMB.
PL0572.00.01	Sem soquete tipo original	Amarelo	-	10
REPOSIÇÃO	DESCRIÇÃO	COR	REF. ORIGINAL	EMB.
PL0573.00.01	Lente para lanterna PL0572	Amarelo	TAC 949 101	20

PL 1312

Lanterna traseira
Aplicação ônibus Marcopolo Senior, Torino, Vicino e Fratello



PL1312.00.01



PL1312.00.02



PL1312.00.03



PL9900.17.94 PL9901.37.94 PL9951.37.00

SOQUETE LED Disponível
Saiba mais na página 23

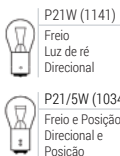

CÓDIGO	DESCRIÇÃO	COR	REF. ORIGINAL	EMB.
PL1312.00.01	Lanterna direcional	Amarelo	262007082	08
PL1312.00.02	Lanterna luz de ré	Cristal	262006734	08
PL1312.00.03	Lanterna posição e freio	Vermelho	262006740	08
REPOSIÇÃO	DESCRIÇÃO	COR	REF. ORIGINAL	EMB.
PL9900.17.94	Soquete 1 polo universal	-	-	10
PL9901.37.94	Soquete 2 polos universal	-	-	10
PL9950.17.00	Chicote 2 vias com guarda pó para Faston 6,3mm	-	-	10
PL9951.37.00	Chicote 3 vias com guarda pó para Faston 6,3mm	-	-	10

PL 1338

Lanterna direcional e delimitadora LED
Aplicação ônibus Apache



PL1338.21.61

LED

69mm

CÓDIGO	DESCRIÇÃO	COR	EMB.
PL1338.21.61	Com cabos para adaptação	Amarelo	01

PL 1302

Lanterna dianteira ou traseira metalizada
Aplicação ônibus



PL1302.00.01

PL1302.00.02

PL1302.00.03



CÓDIGO	DESCRIÇÃO	COR	REF. ORIGINAL	EMB.
PL1302.00.01	Lanterna direcional	Amarelo	2620.1127	10
PL1302.00.02	Lanterna direcional ou luz de ré	Cristal	2620.1128	10
PL1302.00.03	Lanterna posição e freio	Vermelho	2620.1126	10

PL 1318

Lanterna dianteira ou traseira
Aplicação ônibus Busscar, Caio, Neobus, Metalbus, Mascarello e Comil



PL1318.00.01

PL1318.00.02

PL1318.00.03



PL9900.17.94 PL9901.37.94 PL9951.37.00

SOQUETE LED Disponível
Saiba mais na página 23



CÓDIGO	DESCRIÇÃO	COR	REF. ORIGINAL	EMB.
PL1318.00.01	Lanterna direcional	Amarelo	42006292	10
PL1318.00.02	Lanterna direcional ou luz de ré	Cristal	85006294	10
PL1318.00.03	Lanterna posição e freio	Vermelho	85006293	10
REPOSIÇÃO	DESCRIÇÃO	COR	REF. ORIGINAL	EMB.
PL9900.17.94	Soquete 1 polo universal	-	-	10
PL9901.37.94	Soquete 2 polos universal	-	-	10
PL9950.17.00	Chicote 2 vias com guarda pó para Faston 6,3mm	-	-	10
PL9951.37.00	Chicote 3 vias com guarda pó para Faston 6,3mm	-	-	10





PL 0704

Lanterna direcional
Aplicação ônibus, caminhões VL e universal



PL0704.00.01



Vista parte traseira



R5W (67)
Posição

CÓDIGO	DESCRIÇÃO	COR	EMB.
PL0704.00.01	Sem soquete	Amarelo	10



PL0704.41.01



Vista parte traseira



R5W (67)
Posição

CÓDIGO	DESCRIÇÃO	COR	EMB.
PL0704.41.01	Com luva e soquete	Amarelo	10



PL0704.31.01



Vista parte traseira



R5W (67)
Posição

CÓDIGO	DESCRIÇÃO	COR	REF. ORIGINAL	EMB.
PL0704.31.01	Com luva, soquete e rabicho	Amarelo	37201043 ou 8121815	10



PL0704.00.41



Vista parte traseira

LED BIVOLT

TENSÃO	COR	EMB.
LED BIVOLT	Amarelo	10

CÓDIGO	DESCRIÇÃO	COR	EMB.
PL0704.00.41	Com LED	Amarelo	10



PL0705.00.01

REPOSIÇÃO	DESCRIÇÃO	COR	EMB.
PL0705.00.01	Lente para lanterna PL0704	Amarelo	20

PL 1308

Lanterna delimitadora em LED com retrorefletor
Aplicação ônibus Busscar, Neobus, Ciferal, Caio, Metalbus, Unibus e Marcopolo



PL1308.00.61



PL1308.51.62

COM LED
AMARELO



Vista parte traseira



PL9946.41.00

PL9946.17.00

CÓDIGO	DESCRIÇÃO	TENSÃO	LENTE	COR	EMB.
PL1308.00.61	Com conector tipo original	LED BIVOLT	Acrílica	Amarelo	10
PL1308.51.62	Com conector tipo original	LED BIVOLT	Acrílica	Cristal	10
REPOSIÇÃO	DESCRIÇÃO				EMB.
PL9946.17.00	Chicote universal com conector 2 vias				10
PL9946.41.00	Chicote universal com conector 2 vias e conector faston				10



PL1308.13.61



Vista parte traseira

CÓDIGO	DESCRIÇÃO	TENSÃO	LENTE	COR	EMB.
PL1308.13.61	Com fio para adaptação	LED BIVOLT	Acrílica	Amarelo	10

PL 1310

Lanterna delimitadora com retrorefletor
Aplicação ônibus

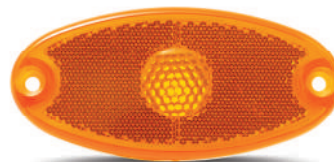

PL1310.00.01



Vista lateral



R5W (67)
Posição

CÓDIGO	DESCRIÇÃO	COR	REF. ORIGINAL	EMB.
PL1310.00.01	Sem soquete	Amarelo	26200678-6	10

PL 1314

Lanterna direcional e delimitadora
Aplicação Ford 1119 e 816 e ônibus



PL1314.00.21



Vista parte lateral

SOQUETE
LED
Disponível

Saiba mais na página 23



P21W (1141)
Direcional

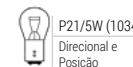

P21/5W (1034)
Direcional e
Posição

CÓDIGO	DESCRIÇÃO	LENTE	COR	REF. ORIGINAL	EMB.
PL9900.17.94	Soquete 1 polo universal				10
PL9901.37.94	Soquete 2 polos universal				10
PL9950.17.00	Chicote 2 vias com guarda pó para Faston 6,3mm				10
PL9951.37.00	Chicote 3 vias com guarda pó para Faston 6,3mm				10
PL1314.00.21	Sem soquete	Acrílico	Amarelo	EC45 13B376 AD (Direito) EC45 13B377 AD (Esquerdo)	10

REPOSIÇÃO	DESCRIÇÃO	EMB.
PL9900.17.94	Soquete 1 polo universal	10
PL9901.37.94	Soquete 2 polos universal	10
PL9950.17.00	Chicote 2 vias com guarda pó para Faston 6,3mm	10
PL9951.37.00	Chicote 3 vias com guarda pó para Faston 6,3mm	10

PL 0554

Lanterna delimitadora
Aplicação ônibus e caminhões VW



PL0554.00.02



PL0554.00.01



PL0555.00.02

CÓDIGO	DESCRIÇÃO	COR	REF. ORIGINAL	EMB.
PL0554.00.02	Lanterna delimitadora	Cristal	2TA 945 05 1B	15
PL0554.00.01	Lanterna delimitadora	Amarelo	-	15
REPOSIÇÃO	DESCRIÇÃO	COR	REF. ORIGINAL	EMB.
PL0555.00.02	Lente para lanterna PL0554	Cristal	2TA 945 425	15



R5W (67)
Posição



ÔNIBUS

PL 1316

Lanterna lateral
Aplicação ônibus

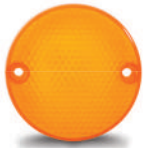

PL1316.00.01



PL1316.00.02



PL1316.00.03

70mm



Vista parte lateral



PL9913.17.97



T4W (69)
Posição

CÓDIGO	DESCRIÇÃO	COR	REF. ORIGINAL	EMB.
PL1316.00.01	Sem soquete	Amarelo	26200717-1	15
PL1316.00.02	Sem soquete	Cristal	26200675-7	15
PL1316.00.03	Sem soquete	Vermelho	26200681-7	15
REPOSIÇÃO	DESCRIÇÃO <td></td> <td></td> <td>EMB.</td>			EMB.
PL9913.17.97	Soquete com 1 polo universal		Ref. Original - MB 345.544.01.93 - VL 344-130	20

PL 1340

Lanterna delimitadora



PL1340.41.01



PL1340.41.02



PL1340.41.03



PL1341.00.01



PL1341.00.02



PL1341.00.03

R5W (67)
Posição

CÓDIGO	DESCRIÇÃO	COR	REF. ORIGINAL	EMB.
PL1340.41.01	Com soquete interno	Amarelo	10201285-2	10
PL1340.41.02	Com soquete interno	Cristal	10201283-0	10
PL1340.41.03	Com soquete interno	Vermelho	10201284-6	10
REPOSIÇÃO	DESCRIÇÃO <td></td> <td></td> <td>EMB.</td>			EMB.
PL1341.00.01	Lente para lanterna PL1340	Amarelo		10
PL1341.00.02	Lente para lanterna PL1340	Cristal		10
PL1341.00.03	Lente para lanterna PL1340	Vermelho		10

PL 0760

Lanterna com 10 LEDs
para suporte traseiro aplicação universal

LED BIVOLT



PL0760.00.61

125mm

1 polo



PL0760.00.62

125mm

1 polo



PL0760.00.63

125mm

2 polos



PL9950.17.00



PL9951.37.00

CÓDIGO	DESCRIÇÃO	TENSÃO	LENTE	COR	EMB.
PL0760.00.61	Lanterna direcional	LED BIVOLT	Acrílica	Amarelo	01
PL0760.00.62	Lanterna luz de ré	LED BIVOLT	Acrílica	Cristal	01
PL0760.00.63	Lanterna posição e freio	LED BIVOLT	Acrílica	Vermelho	01
REPOSIÇÃO	DESCRIÇÃO <td></td> <td></td> <td></td> <td>EMB.</td>				EMB.
PL9950.17.00	Chicote 2 vias com guarda pó para Faston 6,3mm				10
PL9951.37.00	Chicote 3 vias com guarda pó para Faston 6,3mm				10

PL 0762

Lanterna com 10 LEDs
para suporte traseiro aplicação universal

LED BIVOLT



PL0762.00.61

125mm

1 polo



PL0762.00.62

125mm

1 polo



PL0762.00.63

125mm

2 polos



PL9950.17.00



PL9951.37.00

CÓDIGO	DESCRIÇÃO	TENSÃO	LENTE	COR	EMB.
PL0762.00.61	Lanterna direcional	LED BIVOLT	Acrílica	Amarelo	01
PL0762.00.62	Lanterna luz de ré	LED BIVOLT	Acrílica	Cristal	01
PL0762.00.63	Lanterna posição e freio	LED BIVOLT	Acrílica	Vermelho	01
REPOSIÇÃO	DESCRIÇÃO <td></td> <td></td> <td></td> <td>EMB.</td>				EMB.
PL9950.17.00	Chicote 2 vias com guarda pó para Faston 6,3mm				10
PL9951.37.00	Chicote 3 vias com guarda pó para Faston 6,3mm				10

PL 0526

Lanterna universal
e aplicação em suportes traseiros

125mm



PL0526.00.01



PL0526.00.02



PL0526.00.03



PL9950.17.00

SOQUETE
LED
Disponível

Saiba mais na página 23

P21W (1141)
Freio
Luz de ré
Direcional

P21/5W (1034)
Freio e Posição
Direcional e
Posição

CÓDIGO	DESCRIÇÃO	COR	REF. ORIGINAL	EMB.
PL0526.00.01	Lanterna direcional	Amarelo	210102062	10
PL0526.00.02	Lanterna luz de ré	Cristal	-	10
PL0526.00.03	Lanterna posição e freio	Vermelho	-	10
REPOSIÇÃO	DESCRIÇÃO <td></td> <td></td> <td>EMB.</td>			EMB.
PL9900.17.94	Soquete 1 polo universal			10
PL9901.37.94	Soquete 2 polos universal			10
PL9950.17.00	Chicote 2 vias com guarda pó para Faston 6,3mm			10
PL9951.37.00	Chicote 3 vias com guarda pó para Faston 6,3mm			10

PL 0582

Lanterna com lente lisa aplicação ônibus e implementos

125mm

SOQUETE
LED
Disponível

Saiba mais na página 23



PL0582.00.01



PL0582.00.02



PL0582.00.23

P21W (1141)
Freio
Luz de ré
Direcional



PL9900.17.94



PL9901.37.94



PL9950.17.00



PL9951.37.00

P21/5W (1034)
Freio e Posição
Direcional e
Posição

CÓDIGO	DESCRIÇÃO	LENTE	COR	REF. ORIGINAL	EMB.
PL0582.00.01	Lanterna direcional	-	Amarelo	92210025001	10
PL0582.00.02	Lanterna luz de ré	-	Cristal	92210026001	10
PL0582.00.23	Lanterna posição e freio	Acrílica	Vermelho	92210024001	10
REPOSIÇÃO	DESCRIÇÃO <td></td> <td></td> <td></td> <td>EMB.</td>				EMB.
PL9900.17.94	Soquete 1 polo universal				10
PL9901.37.94	Soquete 2 polos universal				10
PL9950.17.00	Chicote 2 vias com guarda pó para Faston 6,3mm				10
PL9951.37.00	Chicote 3 vias com guarda pó para Faston 6,3mm				10



PL 0756

Lanterna com lente lisa
aplicação ônibus e implementos



PL0756.23.01 PL0756.23.02 PL0756.23.03 PL0756.23.04



Disponível
Saiba mais na página 23

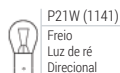

P21W (1141)
Freio
Luz de ré
Direcional



P21/5W (1034)
Freio e Posição
Direcional e
Posição



PL9900.17.94 PL9901.37.94 PL9950.17.00 PL9951.37.00

CÓDIGO	DESCRIÇÃO	COR	REF. ORIGINAL	EMB.
PL0756.23.01	Lanterna direcional	Amarelo	213000113	10
PL0756.23.02	Lanterna luz de ré	Cristal	-	10
PL0756.23.03	Lanterna posição e freio	Vermelho	213000112	10
PL0756.23.04	Lanterna luz de ré	Fumê	-	10
REPOSIÇÃO	DESCRIÇÃO			EMB.
PL9900.17.94	Soquete 1 polo universal			10
PL9901.37.94	Soquete 2 polos universal			10
PL9950.17.00	Chicote 2 vias com guarda pó para Faston 6,3mm			10
PL9951.37.00	Chicote 3 vias com guarda pó para Faston 6,3mm			10

PL 0758

Lanterna com retrorrefletor
aplicação ônibus e implementos



PL0758.00.07 PL0758.00.08



Disponível
Saiba mais na página 23

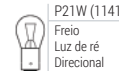

P21W (1141)
Freio
Luz de ré
Direcional

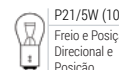

P21/5W (1034)
Freio e Posição
Direcional e
Posição



CÓDIGO DESCRIÇÃO COR REF. ORIGINAL EMB.

PL0758.00.07	Lanterna luz de ré	Vermelho e cristal	213000114	10
PL0758.00.08	Lanterna luz de ré	Vermelho e fumê	-	10
REPOSIÇÃO	DESCRIÇÃO			EMB.
PL9900.17.94	Soquete 1 polo universal			10
PL9901.37.94	Soquete 2 polos universal			10
PL9950.17.00	Chicote 2 vias com guarda pó para Faston 6,3mm			10
PL9951.37.00	Chicote 3 vias com guarda pó para Faston 6,3mm			10

PL 0562

Lanterna aplicação Facchini 1ª geração



PL0562.00.01 PL0562.00.02 PL0562.00.23



Disponível
Saiba mais na página 23

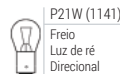

P21W (1141)
Freio
Luz de ré
Direcional



P21/5W (1034)
Freio e Posição
Direcional e
Posição



PL9900.17.94 PL9901.37.94 PL9950.17.00 PL9951.37.00

CÓDIGO	DESCRIÇÃO	LENTE	COR	EMB.
PL0562.00.01	Lanterna direcional	-	Amarelo	10
PL0562.00.02	Lanterna luz de ré	-	Cristal	10
PL0562.00.23	Lanterna posição e freio	Acrílica	Vermelho	10
REPOSIÇÃO	DESCRIÇÃO			EMB.
PL9900.17.94	Soquete 1 polo universal			10
PL9901.37.94	Soquete 2 polos universal			10
PL9950.17.00	Chicote 2 vias com guarda pó para Faston 6,3mm			10
PL9951.37.00	Chicote 3 vias com guarda pó para Faston 6,3mm			10

PL 1354

Lanterna traseira com fixação frontal



PL1354.00.01 PL1354.00.02 PL1354.00.03



Disponível
Saiba mais na página 23

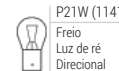

P21W (1141)
Freio
Luz de ré
Direcional

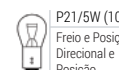

P21/5W (1034)
Freio e Posição
Direcional e
Posição



CÓDIGO DESCRIÇÃO COR REF. ORIGINAL EMB.

PL1354.00.01	Lanterna direcional	Amarelo	6233239M91	10
PL1354.00.02	Lanterna luz de ré	Cristal	-	10
PL1354.00.03	Lanterna posição e freio	Vermelho	6233240M91	10
REPOSIÇÃO	DESCRIÇÃO			EMB.
PL9900.17.94	Soquete 1 polo universal			10
PL9901.37.94	Soquete 2 polos universal			10
PL9950.17.00	Chicote 2 vias com guarda pó para Faston 6,3mm			10
PL9951.37.00	Chicote 3 vias com guarda pó para Faston 6,3mm			10

PL 0558

Lanterna aplicação Facchini 2ª geração

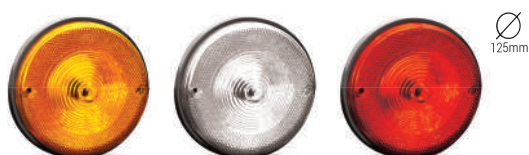

PL0558.00.01 PL0558.00.02 PL0558.00.03



Disponível
Saiba mais na página 23



P21W (1141)
Freio
Luz de ré
Direcional



P21/5W (1034)
Freio e Posição
Direcional e
Posição



PL9900.17.94 PL9901.37.94 PL9950.17.00 PL9951.37.00

CÓDIGO	DESCRIÇÃO	COR	EMB.
PL0558.00.01	Lanterna direcional	Amarelo	10
PL0558.00.02	Lanterna luz de ré	Cristal	10
PL0558.00.03	Lanterna posição e freio	Vermelho	10
REPOSIÇÃO	DESCRIÇÃO		EMB.
PL9900.17.94	Soquete 1 polo universal		10
PL9901.37.94	Soquete 2 polos universal		10
PL9950.17.00	Chicote 2 vias com guarda pó para Faston 6,3mm		10
PL9951.37.00	Chicote 3 vias com guarda pó para Faston 6,3mm		10

PL 1356

Lanterna traseira com lente lisa



PL1356.23.01 PL1356.23.02 PL1356.23.03



Disponível
Saiba mais na página 23

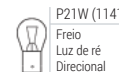

P21W (1141)
Freio
Luz de ré
Direcional

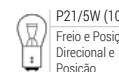

P21/5W (1034)
Freio e Posição
Direcional e
Posição



CÓDIGO DESCRIÇÃO COR REF. ORIGINAL EMB.

PL1356.23.01	Lanterna direcional com lente lisa	Amarelo	10
PL1356.23.02	Lanterna luz de ré com lente lisa	Cristal	10
PL1356.23.03	Lanterna posição e freio com lente lisa	Vermelho	10
REPOSIÇÃO	DESCRIÇÃO		EMB.
PL9900.17.94	Soquete 1 polo universal		10
PL9901.37.94	Soquete 2 polos universal		10
PL9950.17.00	Chicote 2 vias com guarda pó para Faston 6,3mm		10
PL9951.37.00	Chicote 3 vias com guarda pó para Faston 6,3mm		10



ÔNIBUS

PL 0590

Lanterna interna plafonier



PL0590.81.02

CÓDIGO	DESCRIÇÃO	COR	EMB.
PL0590.81.02	Sem interruptor	Cristal	05



C5W Interno

PL 1427

Refletivo traseiro
Aplicação ônibus, MB Accello, Sprinter e universal

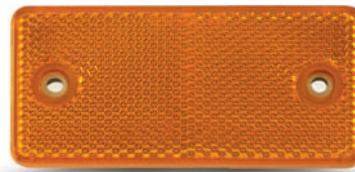

PL1427.00.21

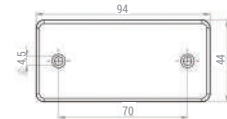

CÓDIGO	DESCRIÇÃO	LENTE	COR	REF. ORIGINAL	EMB.
PL1427.00.21	Refletivo traseiro	Acrílica	Amarelo	A0 008 262 240	30

PL 0610

Lanterna interna tipo Gabriela

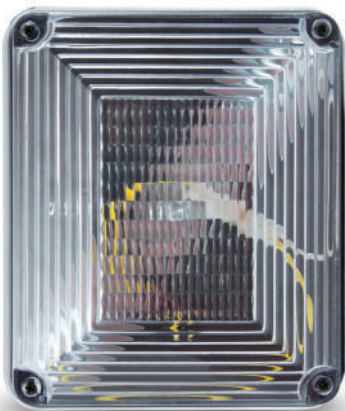

PL0610.00.02

CÓDIGO	DESCRIÇÃO	COR	EMB.
PL0610.00.02	Sem interruptor	Cristal	05



C5W Interno



PL0610.20.02

CÓDIGO	DESCRIÇÃO	COR	EMB.
PL0610.20.02	Com interruptor	Cristal	05



C5W Interno

PL 0523

Refletivo "olho de gato" 80mm



PL0523.00.23



PL0523.00.21

80mm



Vista parte traseira

CÓDIGO	DESCRIÇÃO	LENTE	COR	EMB.
PL0523.00.23	Refletivo com parafuso	Acrílica	Vermelho	15
PL0523.00.21	Refletivo com parafuso	Acrílica	Amarelo	15

PL 1527

Refletivo "olho de gato" 60mm



PL1527.00.21



PL1527.00.23

60mm



Vista parte traseira

CÓDIGO	DESCRIÇÃO	LENTE	COR	REF. ORIGINAL	EMB.
PL1527.00.21	Refletivo com parafuso	Acrílica	Amarelo	693 544 00 05	30
PL1527.00.23	Refletivo com parafuso	Acrílica	Cristal	-	30



PL1527.21.21

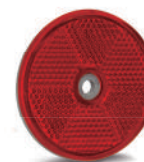

PL1527.21.23

60mm



Vista parte traseira

CÓDIGO	DESCRIÇÃO	LENTE	COR	EMB.
PL1527.21.21	Refletivo com furo central	Acrílica	Amarelo	30
PL1527.21.23	Refletivo com furo central	Acrílica	Vermelho	30



PL 1010

Lanterna traseira sem soquete
Aplicação Ford Ranger 2013 a 2016



PL1010.01.27 - Lado direito
PL1010.02.27 - Lado esquerdo

CÓDIGO	DESCRIÇÃO	LENTE	LADO	COR	REF. ORIGINAL	EMB.
PL1010.01.27	Lanterna traseira	Acrílica	Direito	Bicolor	AB3913404FA	01
PL1010.02.27	Lanterna traseira	Acrílica	Esquerdo	Bicolor	AB3913405FA	01



PL 0680

Lanterna direcional
Aplicação F1000 e F4000 (1992 a 1997)



PL0680.01.01 - Lado Direito
PL0680.02.01 - Lado esquerdo
PL0680.01.02 - Lado direito
PL0680.02.02 - Lado esquerdo



CÓDIGO	DESCRIÇÃO	LADO	COR	EMB.
PL0680.01.01	Lanterna direcional	Direito	Amarelo	02
PL0680.02.01	Lanterna direcional	Esquerdo	Amarelo	02
PL0680.01.02	Lanterna direcional	Direito	Cristal	02
PL0680.02.02	Lanterna direcional	Esquerdo	Cristal	02

PL 0402

Lanterna traseira
Aplicação pick-up F1000 (92 em diante)



PL0402.01.29 - Lado direito
PL0402.02.29 - Lado esquerdo

CÓDIGO	DESCRIÇÃO	LENTE	LADO	COR	REF. ORIGINAL	EMB.
PL0402.01.29	Lanterna traseira	Acrílica	Direito	Tricolor	ZAC 945096	01
PL0402.02.29	Lanterna traseira	Acrílica	Esquerdo	Tricolor	ZAC 945095	01



PL 0307

Lente para lanterna traseira
Aplicação pick-up Chevrolet A / C / D 10-14 (até 85)



CÓDIGO	DESCRIÇÃO	COR	EMB.
PL0307.00.03	Lente para lanterna traseira Chevrolet	Vermelho	10

PL 0468

Lanterna traseira
Aplicação pick-up F250



PL0468.01.29 - Lado direito
PL0468.02.29 - Lado esquerdo

CÓDIGO	DESCRIÇÃO	LENTE	LADO	COR	REF. ORIGINAL	EMB.
PL0468.01.29	Lanterna traseira	Acrílica	Direito	Tricolor	YC3513409ABX (D)	01
PL0468.02.29	Lanterna traseira	Acrílica	Esquerdo	Tricolor	YC3513409ABX (E)	01



PL 0422

Lanterna traseira
Aplicação pick-up Chevrolet A / G / D-20 (86 em diante)



PL0423.01.09 - Lente - LD
PL0423.02.09 - Lente - LE

CÓDIGO	DESCRIÇÃO	LADO	COR	REF. ORIGINAL	EMB.
PL0422.01.09	Lanterna traseira	Direito	Tricolor	94 632 188	06
PL0422.02.09	Lanterna traseira	Esquerdo	Tricolor	94 632 187	06
REPOSIÇÃO	DESCRIÇÃO	LADO	COR	REF. ORIGINAL	EMB.
PL0423.01.09	Lente para lanterna PL0422	Direito	Tricolor	94 649 305	20
PL0423.02.09	Lente para lanterna PL0422	Esquerdo	Tricolor	94 649 304	20





UTILITÁRIOS

PL 0424

Lanterna direcional

Aplicação Opala / Caravan / pick-up A / G / D-20 - 40 84 a 91

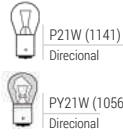

PL0424.01.01 - Lado direito

PL0424.03.02 - Lado direito

PL0424.02.01 - Lado esquerdo

PL0424.04.02 - Lado esquerdo

CÓDIGO	DESCRIÇÃO	LADO	COR	REF. ORIGINAL	EMB.
PL0424.01.01	Lanterna direcional	Direito	Amarelo	94 642 843	08
PL0424.02.01	Lanterna direcional	Esquerdo	Amarelo	94 642 843	08
PL0424.03.02	Lanterna direcional com cúpula	Direito	Cristal	-	08
PL0424.04.02	Lanterna direcional com cúpula	Esquerdo	Cristal	-	08

PL 0488

Lanterna direcional

Aplicação MB Sprinter 1995 a 2012



PL0488.01.22 - LD

PL0488.02.22 - LE

CÓDIGO	DESCRIÇÃO	LENTE	LADO	COR	REF. ORIGINAL	EMB.
PL0488.01.22	Lanterna direcional	Acrílica	Direito	Cristal	901 820 02 21	02
PL0488.02.22	Lanterna direcional	Acrílica	Esquerdo	Cristal	901 820 01 21	02

PL 1016

Lanterna traseira sem soquete

Aplicação MB Sprinter a partir de 2012



PL1016.01.27 - Lado direito

PL1016.02.27 - Lado esquerdo

CÓDIGO	DESCRIÇÃO	LENTE	LADO	COR	REF. ORIGINAL	EMB.
PL1016.01.27	Lanterna traseira	Acrílica	Direito	Bicolor	A9068200264	01
PL1016.02.27	Lanterna traseira	Acrílica	Esquerdo	Bicolor	A9068200164	01

PL 1006

Lanterna traseira sem soquete

Aplicação Mitsubishi L200 2007 a 2015

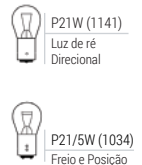

PL1006.01.29 - Lado direito

PL1006.02.29 - Lado esquerdo

CÓDIGO	DESCRIÇÃO	LENTE	LADO	COR	REF. ORIGINAL	EMB.
PL1006.01.29	Lanterna traseira	Acrílica	Direito	Tricolor	8330A010	01
PL1006.02.29	Lanterna traseira	Acrílica	Esquerdo	Tricolor	8330A009	01

PL 0490

Lanterna traseira

Aplicação MB Sprinter



Para Sprinter 2003 a 2011

PL0490.21.27 - LD

PL0490.22.27 - LE

Para Sprinter 1995 a 2002

PL0490.01.29 - LD

PL0490.02.29 - LE

CÓDIGO	DESCRIÇÃO	LENTE	LADO	COR	REF. ORIGINAL	EMB.
PL0490.21.27	Lanterna traseira	Acrílica	Direito	Bicolor	000 826 16 56	01
PL0490.22.27	Lanterna traseira	Acrílica	Esquerdo	Bicolor	000 826 15 56	01
PL0490.01.29	Lanterna traseira	Acrílica	Direito	Tricolor	901 820 08 64	01
PL0490.02.29	Lanterna traseira	Acrílica	Esquerdo	Tricolor	901 820 07 64	01

PL 1008

Lanterna traseira sem soquete

Aplicação Mitsubishi L200 2016 a 2018

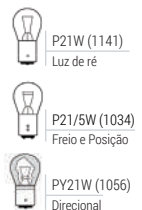

PL1008.01.27 - Lado direito

PL1008.02.27 - Lado esquerdo

CÓDIGO	DESCRIÇÃO	LENTE	LADO	COR	REF. ORIGINAL	EMB.
PL1008.01.27	Lanterna traseira	Acrílica	Direito	Bicolor	8330A944	01
PL1008.02.27	Lanterna traseira	Acrílica	Esquerdo	Bicolor	8330A943	01



PL 1014

Lanterna traseira sem soquete
Aplicação S-10 LT 2012 a 2016



PL1014.01.27 - Lado direito
PL1014.02.27 - Lado esquerdo



CÓDIGO	DESCRIÇÃO	LENTE	LADO	COR	REF. ORIGINAL	EMB.
PL1014.01.27	Lanterna traseira	Acrílica	Direito	Bicolor	94728019	01
PL1014.02.27	Lanterna traseira	Acrílica	Esquerdo	Bicolor	94728020	01

PL 1012

Lanterna traseira sem soquete
Aplicação VW Amarok 2010 a 2016



PL1012.01.27 - Lado direito
PL1012.02.27 - Lado esquerdo



CÓDIGO	DESCRIÇÃO	LENTE	LADO	COR	REF. ORIGINAL	EMB.
PL1012.01.27	Lanterna traseira	Acrílica	Direito	Bicolor	2H1945096B	01
PL1012.02.27	Lanterna traseira	Acrílica	Esquerdo	Bicolor	2H2945095B	01

PL 0436

Lanterna traseira
Aplicação pick-up S-10 (1995 a 2000)



PL0436.01.29 - Lado direito
PL0436.02.29 - Lado esquerdo

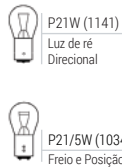

CÓDIGO	DESCRIÇÃO	LENTE	LADO	COR	REF. ORIGINAL	EMB.
PL0436.01.29	Lanterna traseira	Acrílica	Direito	Tricolor	932 16412	01
PL0436.02.29	Lanterna traseira	Acrílica	Esquerdo	Tricolor	932 16411	01

PL 1020

Lanterna traseira sem soquete
Aplicação Frontier a partir de 2016



PL1020.01.27 - Lado direito
PL1020.02.27 - Lado esquerdo

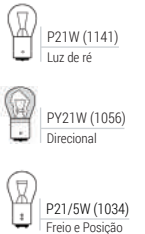

CÓDIGO	DESCRIÇÃO	LENTE	LADO	COR	REF. ORIGINAL	EMB.
PL1020.01.27	Lanterna traseira	Acrílica	Direito	Bicolor	26550-4AJOA	01
PL1020.02.27	Lanterna traseira	Acrílica	Esquerdo	Bicolor	26555-4AJOA	01

PL 0400

Lanterna traseira com chicote
Aplicação Ducato, Peugeot Boxer (2003 em diante) e Citroen Jumper (2003 em diante)



PL0400.31.27 - LD
PL0400.32.27 - LE



PL0400.49.27 - LD
PL0400.50.27 - LE



CÓDIGO	DESCRIÇÃO	LENTE	LADO	COR	REF. ORIGINAL	EMB.
PL0400.31.27	2003 em diante	Acrílica	Direito	Bicolor	1328427080	01
PL0400.32.27	2003 em diante	Acrílica	Esquerdo	Bicolor	1328428080	01
PL0400.49.27	Design 2003 para 1997 a 2002	Acrílica	Direito	Bicolor	-	01
PL0400.50.27	Design 2003 para 1997 a 2002	Acrílica	Esquerdo	Bicolor	-	01

PL 1022

Lanterna traseira sem soquete
Aplicação Frontier 2007 a 2015



PL1022.01.27 - Lado direito
PL1022.02.27 - Lado esquerdo

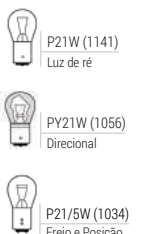

CÓDIGO	DESCRIÇÃO	LENTE	LADO	COR	REF. ORIGINAL	EMB.
PL1022.01.27	Lanterna traseira	Acrílica	Direito	Bicolor	26550-EA825	01
PL1022.02.27	Lanterna traseira	Acrílica	Esquerdo	Bicolor	26555-EA825	01



UTILITÁRIOS

PL 1000

Lanterna traseira sem soquete
Aplicação Hilux 2005 a 2011



PL1000.01.29 - Lado direito
PL1000.02.29 - Lado esquerdo

CÓDIGO	DESCRIÇÃO	LENTE	LADO	COR	REF. ORIGINAL	EMB.
PL1000.01.29	Lanterna traseira	Acrílica	Direito	Tricolor	815510K050	01
PL1000.02.29	Lanterna traseira	Acrílica	Esquerdo	Tricolor	815610K050	01

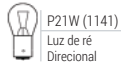

P21W (1141)
Luz de ré
Direcional



P21/5W (1034)
Freio e Posição

PL 1002

Lanterna traseira sem soquete
Aplicação Hilux 2012 a 2015



PL1002.01.27 - Lado direito
PL1002.02.27 - Lado esquerdo

CÓDIGO	DESCRIÇÃO	LENTE	LADO	COR	REF. ORIGINAL	EMB.
PL1002.01.27	Lanterna traseira	Acrílica	Direito	Bicolor	815510K180	01
PL1002.02.27	Lanterna traseira	Acrílica	Esquerdo	Bicolor	815510K190	01



P21W (1141)
Luz de ré



P21/5W (1034)
Freio e Posição



PY21W (1056)
Direcional

PL 1004

Lanterna traseira sem soquete
Aplicação Hilux a partir de 2016



PL1004.01.27 - Lado direito
PL1004.02.27 - Lado esquerdo

CÓDIGO	DESCRIÇÃO	LENTE	LADO	COR	REF. ORIGINAL	EMB.
PL1004.01.27	Lanterna traseira	Acrílica	Direito	Bicolor	815510K260	01
PL1004.02.27	Lanterna traseira	Acrílica	Esquerdo	Bicolor	815610K260	01



P21W (1141)
Luz de ré
Freio



PY21W (1056)
Direcional



R5W (67)
Posição

PL 0440

Lanterna traseira
Aplicação Troller (até 2013)



PL0441.00.07

CÓDIGO	DESCRIÇÃO
PL0440.01.07	Sem vigia
PL0440.02.07	Com vigia
REPOSIÇÃO	DESCRIÇÃO
PL0441.00.07	Lente lanterna PL0440

LADO	COR	EMB.
Direito	Bicolor	06
Esquerdo	Bicolor	06
Cor	EMB.	
Bicolor	30	

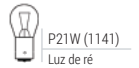

P21W (1141)
Luz de ré



P21/5W (1034)
Freio e Posição



PY21W (1056)
Direcional

PL 0410

Lanterna direcional
Aplicação Toyota Bandeirante



PL0410.37.01 - Lado direito
PL0410.38.01 - Lado esquerdo



PL0410.17.01 - Lado direito
PL0410.18.01 - Lado esquerdo

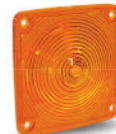

PL0409.00.01

CÓDIGO	DESCRIÇÃO	LADO	COR	REF. ORIGINAL	EMB.
PL0410.37.01	Com 2 faces e 2 polos	Direito	Amarelo	81 510 98 002	15
PL0410.38.01	Com 2 faces e 2 polos	Esquerdo	Amarelo	81 520 98 002	15
PL0410.17.01	Com 1 face e 1 polo	Direito	Amarelo	-	15
PL0410.18.01	Com 1 face e 1 polo	Esquerdo	Amarelo	-	15
CÓDIGO	DESCRIÇÃO	COR	REF. ORIGINAL	EMB.	
PL0409.00.01	Lente para lanterna PL0408	Amarelo	001 822 55 10	20	



P21W (1141)
Direcional

PL 0516

Lanterna traseira
Aplicação Toyota Bandeirante



PL0516.21.09 - Sem vigia - LD
PL0516.22.09 - Com vigia - LE



PL0517.21.09

CÓDIGO	DESCRIÇÃO	LADO	COR	REF. ORIGINAL	EMB.
PL0516.21.09	Sem vigia	Direito	Tricolor	81 510 98 004	08
PL0516.22.09	Com vigia	Esquerdo	Tricolor	81 551 98 003	08
CÓDIGO	DESCRIÇÃO	COR	EMB.		
PL0517.21.09	Lente para lanterna PL0516	Tricolor	20		

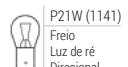

P21W (1141)
Freio
Luz de ré
Direcional



R5W (67)
Posição



PL 0802

Lanterna traseira blindada LED 3 funções

Aplicação universal.
Função direcional, posição e freio.
Lente em acrílico.

LED BIVOLT



Lanterna acesa

CÓDIGO	DESCRIÇÃO	TENSÃO	LENTE	COR	EMB.
PL0802.00.67	Com 8 LEDs	LED BIVOLT	Acrílico	Bicolor	10

PL 0804

Lanterna traseira blindada LED 4 funções

Aplicação universal.
Função direcional, luz de ré, posição e freio.
Lente em acrílico.

LED BIVOLT



Lanterna acesa

CÓDIGO	DESCRIÇÃO	TENSÃO	LENTE	COR	EMB.
PL0804.00.67	Com 8 LEDs	LED BIVOLT	Acrílico	Bicolor	10

PL 0502

Lanterna traseira com base plástica



PL0502.00.05



PL0503.00.05



Vista parte traseira



P21W (1141)
Luz de ré
Direcional



P21/5W (1034)
Freio e Posição

CÓDIGO	DESCRIÇÃO	COR	EMB.
PL0502.00.05	Lanterna traseira	Amarelo e Vermelho	10
REPOSIÇÃO	DESCRIÇÃO	COR	EMB.
PL0503.00.05	Lente para lanterna PL0502	Amarelo e Vermelho	10

PL 0602

Lanterna traseira conjunto com 4 lentes



PL0602.71.09

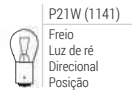

P21W (1141)
Freio
Luz de ré
Direcional
Posição

CÓDIGO	DESCRIÇÃO	COR	EMB.
PL0602.71.09	Com borda arredondada	Tricolor	08



PL0599.29.01



PL0599.29.02



PL0599.29.03

REPOSIÇÃO	DESCRIÇÃO	COR	EMB.
PL0599.29.01	Lente com borda arredondada para lanterna PL0602	Amarelo	20
PL0599.29.02	Lente com borda arredondada para lanterna PL0602	Cristal	20
PL0599.29.03	Lente com borda arredondada para lanterna PL0602	Vermelho	20

PL 0542

Lanterna traseira universal para para-choque



PL0542.00.05



PL0543.00.05



P21W (1141)
Luz de ré



P21/5W (1034)
Freio e Posição

CÓDIGO	DESCRIÇÃO	COR	EMB.
PL0542.00.05	Lanterna traseira	Amarelo e Vermelho	15
REPOSIÇÃO	DESCRIÇÃO	COR	EMB.
PL0543.00.05	Lente para lanterna PL0542	Amarelo e Vermelho	10

PL 0604

Lanterna traseira conjunto com 3 lentes



PL0604.70.09

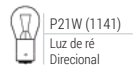

P21W (1141)
Luz de ré
Direcional



P21/5W (1034)
Freio e Posição

CÓDIGO	DESCRIÇÃO	COR	EMB.
PL0604.70.09	Com borda arredondada	Tricolor	05



PL0599.29.01



PL0599.29.02



PL0599.29.03

REPOSIÇÃO	DESCRIÇÃO	COR	EMB.
PL0599.29.01	Lente com borda arredondada para lanterna PL0604	Amarelo	20
PL0599.29.02	Lente com borda arredondada para lanterna PL0604	Cristal	20
PL0599.29.03	Lente com borda arredondada para lanterna PL0604	Vermelho	20



ACESSÓRIOS

PL 0600

Lanterna lateral
Aplicação Facchini



PL0600.29.01



PL0600.29.02



PL0600.29.03



CÓDIGO	DESCRIÇÃO	COR	EMB.
PL0600.29.01	Com borda arredondada	Amarelo	20
PL0600.29.02	Com borda arredondada	Cristal	20
PL0600.29.03	Com borda arredondada	Vermelho	20

LED BIVOLT



PL0600.29.41



PL0600.29.42



PL0600.29.43

CÓDIGO	DESCRIÇÃO	TENSÃO	COR	EMB.
PL0600.29.41	Com borda arredondada	LED BIVOLT	Amarelo	10
PL0600.29.42	Com borda arredondada	LED BIVOLT	Cristal	10
PL0600.29.43	Com borda arredondada	LED BIVOLT	Vermelho	10



PL0599.29.01



PL0599.29.02



PL0599.29.03

REPOSIÇÃO	DESCRIÇÃO	COR	EMB.
PL0599.29.01	Lente com borda arredondada para lanterna PL0600	Amarelo	20
PL0599.29.02	Lente com borda arredondada para lanterna PL0600	Cristal	20
PL0599.29.03	Lente com borda arredondada para lanterna PL0600	Vermelho	20



PL0600.20.02



CÓDIGO	DESCRIÇÃO	COR	EMB.
PL0600.20.02	Com borda arredondada e interruptor	Cristal	20



PL0600.21.01



PL0600.21.02



PL0600.21.03



CÓDIGO	DESCRIÇÃO	COR	EMB.
PL0600.21.01	Lanterna lateral estreita	Amarelo	20
PL0600.21.02	Lanterna lateral estreita	Cristal	20
PL0600.21.03	Lanterna lateral estreita	Vermelho	20



PL0599.21.01



PL0599.21.02



PL0599.21.03

REPOSIÇÃO	DESCRIÇÃO	COR	EMB.
PL0599.21.01	Lente estreita para lanterna PL0600	Amarelo	20
PL0599.21.02	Lente estreita para lanterna PL0600	Cristal	20
PL0599.21.03	Lente estreita para lanterna PL0600	Vermelho	20



PL0600.00.01



PL0600.00.02

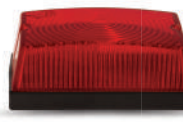

PL0600.00.03



CÓDIGO	DESCRIÇÃO	COR	EMB.
PL0600.00.01	Lanterna lateral	Amarelo	20
PL0600.00.02	Lanterna lateral	Cristal	20
PL0600.00.03	Lanterna lateral	Vermelho	20

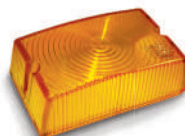

PL0599.00.01



PL0599.00.02

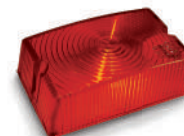

PL0599.00.03

REPOSIÇÃO	DESCRIÇÃO	COR	EMB.
PL0599.00.01	Lente para lanterna PL0600	Amarelo	30
PL0599.00.02	Lente para lanterna PL0600	Cristal	30
PL0599.00.03	Lente para lanterna PL0600	Vermelho	30



PL 0456

Lanterna posição com refletivo
Aplicação ônibus e caminhões



PL0456.29.01

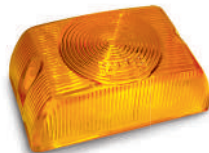

PL0599.29.01



P21W (1141)
Posição

CÓDIGO	DESCRIÇÃO	COR	EMB.
PL0456.29.01	Com refletivo e lente de borda arredondada	Amarelo	10
REPOSIÇÃO	DESCRIÇÃO	COR	EMB.
PL0599.29.01	Lente com borda arredondada para lanterna PL0456	Amarelo	20

PL 0458

Lanterna posição com haste universal



PL0458.29.01

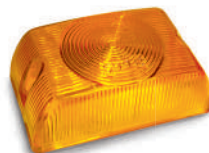

PL0599.29.01



P21W (1141)
Posição

CÓDIGO	DESCRIÇÃO	COR	EMB.
PL0458.29.01	Com haste e lente de borda arredondada	Amarelo	15
REPOSIÇÃO	DESCRIÇÃO	COR	EMB.
PL0599.29.01	Lente com borda arredondada para lanterna PL0458	Amarelo	20



PL0458.00.01

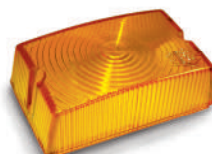

PL0599.00.01



P21W (1141)
Posição

CÓDIGO	DESCRIÇÃO	COR	EMB.
PL0458.00.01	Com haste	Amarelo	15
REPOSIÇÃO	DESCRIÇÃO	COR	EMB.
PL0599.00.01	Lente para lanterna PL0458	Amarelo	30

PL 0452

Lanterna retangular
Aplicação Furgão



PL0452.00.01



PL0452.00.02



PL0452.00.03



T4W (69)
Posição

CÓDIGO	DESCRIÇÃO	COR	EMB.
PL0452.00.01	Lanterna lateral	Amarelo	10
PL0452.00.02	Lanterna lateral	Cristal	10
PL0452.00.03	Lanterna lateral	Vermelho	10

LED BIVOLT

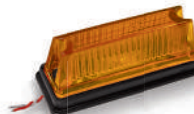

PL0452.00.41



PL0452.00.42



PL0452.00.43

CÓDIGO	DESCRIÇÃO	TENSÃO	COR	EMB.
PL0452.00.41	Lanterna lateral	LED BIVOLT	Amarelo	10
PL0452.00.42	Lanterna lateral	LED BIVOLT	Cristal	10
PL0452.00.43	Lanterna lateral	LED BIVOLT	Vermelho	10



PL0453.00.01



PL0453.00.02



PL0453.00.03

REPOSIÇÃO	DESCRIÇÃO	COR	EMB.
PL0453.00.01	Lente para lanterna PL0452	Amarelo	10
PL0453.00.02	Lente para lanterna PL0452	Cristal	10
PL0453.00.03	Lente para lanterna PL0452	Vermelho	10



PL0452.29.01



PL0452.29.02



PL0452.29.03



T4W (69)
Posição

CÓDIGO	DESCRIÇÃO	COR	EMB.
PL0452.29.01	Lanterna lateral com borda arredondada	Amarelo	10
PL0452.29.02	Lanterna lateral com borda arredondada	Cristal	10
PL0452.29.03	Lanterna lateral com borda arredondada	Vermelho	10

LED BIVOLT



PL0452.29.41



PL0452.29.42



PL0452.29.43

CÓDIGO	DESCRIÇÃO	TENSÃO	COR	EMB.
PL0452.29.41	Lanterna lateral com borda arredondada	LED BIVOLT	Amarelo	10
PL0452.29.42	Lanterna lateral com borda arredondada	LED BIVOLT	Cristal	10
PL0452.29.43	Lanterna lateral com borda arredondada	LED BIVOLT	Vermelho	10



PL0453.29.01



PL0453.29.02



PL0453.29.03

REPOSIÇÃO	DESCRIÇÃO	COR	EMB.
PL0453.29.01	Lente com borda arredondada para lanterna PL0452	Amarelo	25
PL0453.29.02	Lente com borda arredondada para lanterna PL0452	Cristal	25
PL0453.29.03	Lente com borda arredondada para lanterna PL0452	Vermelho	25



ACESSÓRIOS

PL 0414

Lanterna universal

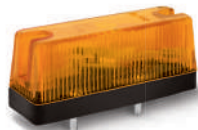

PL0414.00.01



PL0414.00.02



CÓDIGO	DESCRIÇÃO	COR	EMB.
PL0414.00.01	Lanterna universal	Amarelo	10
PL0414.00.02	Lanterna universal	Cristal	10

PL 0418

Lanterna Recrusul e universal



PL0418.00.01

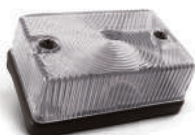

PL0418.00.02



PL0418.00.03



CÓDIGO	DESCRIÇÃO	COR	EMB.
PL0418.00.01	Lanterna Recrusul	Amarelo	15
PL0418.00.02	Lanterna Recrusul	Cristal	15
PL0418.00.03	Lanterna Recrusul	Vermelho	15
REPOSIÇÃO	DESCRIÇÃO	COR	EMB.
PL0419.00.01	Lente para lanterna Recrusul PL0418	Amarelo	20
PL0419.00.02	Lente para lanterna Recrusul PL0418	Cristal	20
PL0419.00.03	Lente para lanterna Recrusul PL0418	Vermelho	20

PL 0404

Lanterna para para-choque



PL0404.60.03



PL0404.60.01



CÓDIGO	DESCRIÇÃO	COR	EMB.
PL0404.60.03	Com 1 face, pedestal e aro preto	Vermelho	15
PL0404.60.01	Com 1 face, pedestal e aro preto	Amarelo	15



PL0404.69.05



CÓDIGO	DESCRIÇÃO	COR	EMB.
PL0404.69.05	com 2 faces, pedestal e aro preto	Amarelo e Vermelho	15



PL0405.00.01



PL0405.00.03

REPOSIÇÃO	DESCRIÇÃO	COR	EMB.
PL0405.00.01	Lente para lanterna PL0404	Amarelo	20
PL0405.00.03	Lente para lanterna PL0404	Vermelho	20

PL 0506

Lanterna universal



93mm

PL0506.00.01



PL0507.00.01



Vista parte traseira



CÓDIGO	DESCRIÇÃO	COR	EMB.
PL0506.00.01	Lanterna universal	Amarelo	20
REPOSIÇÃO	DESCRIÇÃO	COR	EMB.
PL0507.00.01	Lente para lanterna PL0506	Amarelo	20

PL 0508

Lanterna universal com aro preto



PL0508.81.05



PL0509.00.05



Vista parte traseira



CÓDIGO	DESCRIÇÃO	COR	EMB.
PL0508.81.05	Lanterna universal	Amarelo e Vermelho	15
CÓDIGO	DESCRIÇÃO	COR	EMB.
PL0509.00.05	Lente para lanterna PL0508	Amarelo e Vermelho	20

PL 0552

Lanterna traseira
Aplicação universal para furgão tipo Coca-Cola

126mm



PL0552.00.01



PL0552.00.02



PL0552.00.03



PL0553.00.01



PL0553.00.02

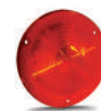

PL0553.00.03

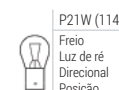

CÓDIGO	DESCRIÇÃO	COR	EMB.
PL0552.00.01	Lanterna traseira	Amarelo	20
PL0552.00.02	Lanterna traseira	Cristal	20
PL0552.00.03	Lanterna traseira	Vermelho	20
REPOSIÇÃO	DESCRIÇÃO	COR	EMB.
PL0553.00.01	Lente para lanterna PL0552	Amarelo	15
PL0553.00.02	Lente para lanterna PL0552	Cristal	15
PL0553.00.03	Lente para lanterna PL0552	Vermelho	15



PL 0130

Conjunto com 3 lanternas PL0326 acopladas



CÓDIGO	DESCRIÇÃO	COR	EMB.
PL0130.00.01	Conjunto com 03 lanternas PL0326	Amarelo	01
PL0130.00.02	Conjunto com 03 lanternas PL0326	Cristal	01
PL0130.00.03	Conjunto com 03 lanternas PL0326	Vermelho	01

PL 0140

Conjunto com 4 lanternas PL0326 acopladas



CÓDIGO	DESCRIÇÃO	COR	EMB.
PL0140.00.01	Conjunto com 04 lanternas PL0326	Amarelo	01
PL0140.00.02	Conjunto com 04 lanternas PL0326	Cristal	01
PL0140.00.03	Conjunto com 04 lanternas PL0326	Vermelho	01

PL 0150

Conjunto com 5 lanternas PL0326 acopladas

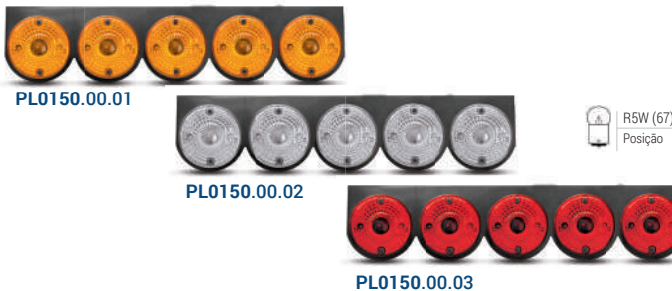

CÓDIGO	DESCRIÇÃO	COR	EMB.
PL0150.00.01	Conjunto com 05 lanternas PL0326	Amarelo	01
PL0150.00.02	Conjunto com 05 lanternas PL0326	Cristal	01
PL0150.00.03	Conjunto com 05 lanternas PL0326	Vermelho	01

PL 0152

Conjunto com 5 lanternas LED PL0690 acopladas



CÓDIGO	DESCRIÇÃO	TENSÃO	COR	EMB.
PL0152.24.41	Conjunto com 05 lanternas PL0690	LED BIVOLT	Amarelo	01
PL0152.24.42	Conjunto com 05 lanternas PL0690	LED BIVOLT	Cristal	01
PL0152.24.43	Conjunto com 05 lanternas PL0690	LED BIVOLT	Vermelho	01

PL 0512

Lanterna lateral universal



CÓDIGO	DESCRIÇÃO	COR	EMB.
PL0512.87.01	Com grade preta e soquete embutido	Amarelo	10
PL0512.87.02	Com grade preta e soquete embutido	Cristal	10
PL0512.87.03	Com grade preta e soquete embutido	Vermelho	10
PL0512.87.12	Com grade preta e soquete embutido	Verde	10



CÓDIGO	DESCRIÇÃO	COR	EMB.
PL0512.81.01	Com aro preto e soquete embutido	Amarelo	10
PL0512.81.02	Com aro preto e soquete embutido	Cristal	10
PL0512.81.03	Com aro preto e soquete embutido	Vermelho	10



CÓDIGO	DESCRIÇÃO	TENSÃO	COR	EMB.
PL0512.87.41	Com grade preta	LED BIVOLT	Amarelo	10



CÓDIGO	DESCRIÇÃO	TENSÃO	COR	EMB.
PL0512.81.41	Com aro preto	LED BIVOLT	Amarelo	10
PL0512.81.42	Com aro preto	LED BIVOLT	Cristal	10
PL0512.81.43	Com aro preto	LED BIVOLT	Vermelho	10



REPOSIÇÃO	DESCRIÇÃO	COR	EMB.
PL0512.81.17	Aro liso para lanternas PL0512	Preto	20
PL0593.00.01	Lente para lanterna PL0512	Amarelo	25
PL0593.00.02	Lente para lanterna PL0512	Cristal	25
PL0593.00.03	Lente para lanterna PL0512	Vermelho	25
PL0593.00.12	Lente para lanterna PL0512	Verde	25



ACESSÓRIOS

PL 0650

Lanterna Ecoline universal para para-choque em pedestal com suporte cromado



PL0650.00.01



PL0650.00.03



PL0650.21.01



PL0650.21.03



CÓDIGO	DESCRIÇÃO	COR	EMB.
PL0650.00.01	Com lente lisa	Amarelo	15
PL0650.00.03	Com lente lisa	Vermelho	15

CÓDIGO	DESCRIÇÃO	COR	EMB.
PL0650.21.01	Com lente bojuda	Amarelo	10
PL0650.21.03	Com lente bojuda	Vermelho	10



PL0525.00.01



PL0525.00.02



PL0525.00.03



PL0650.84.16



PL0525.21.01



PL0525.21.03



PL0650.84.16

REPOSIÇÃO	DESCRIÇÃO	COR	EMB.
PL0525.00.01	Lente lisa para lanterna PL0650	Amarelo	20
PL0525.00.02	Lente lisa para lanterna PL0650	Cristal	20
PL0525.00.03	Lente lisa para lanterna PL0650	Vermelho	20
PL0650.84.16	Aro para lanterna PL0650 em chapa	Cromado	20

REPOSIÇÃO	DESCRIÇÃO	COR	EMB.
PL0525.21.01	Lente bojuda para lanterna PL0650	Amarelo	20
PL0525.21.03	Lente bojuda para lanterna PL0650	Vermelho	20
PL0650.84.16	Aro para lanterna PL0650 em chapa	Cromado	20



PL0650.70.01 - Amarelo
PL0650.70.03 - Vermelho



PL0650.53.01 - Amarelo
PL0650.53.03 - Vermelho



CÓDIGO	DESCRIÇÃO	COR	EMB.
PL0650.70.01	Conjunto com 03 lanternas Ecoline com lente lisa	Amarelo	01
PL0650.70.03	Conjunto com 03 lanternas Ecoline com lente lisa	Vermelho	01

CÓDIGO	DESCRIÇÃO	COR	EMB.
PL0650.53.01	Conjunto com 03 lanternas Ecoline com lente bojuda	Amarelo	01
PL0650.53.03	Conjunto com 03 lanternas Ecoline com lente bojuda	Vermelho	01



PL0650.71.01 - Amarelo
PL0650.71.03 - Vermelho



PL0650.54.01 - Amarelo
PL0650.54.03 - Vermelho



CÓDIGO	DESCRIÇÃO	COR	EMB.
PL0650.71.01	Conjunto com 04 lanternas Ecoline com lente lisa	Amarelo	01
PL0650.71.03	Conjunto com 04 lanternas Ecoline com lente lisa	Vermelho	01

CÓDIGO	DESCRIÇÃO	COR	EMB.
PL0650.54.01	Conjunto com 04 lanternas Ecoline com lente bojuda	Amarelo	01
PL0650.54.03	Conjunto com 04 lanternas Ecoline com lente bojuda	Vermelho	01



PL0650.72.01 - Amarelo
PL0650.72.03 - Vermelho



PL0650.52.01 - Amarelo
PL0650.52.03 - Vermelho



CÓDIGO	DESCRIÇÃO	COR	EMB.
PL0650.72.01	Conjunto com 05 lanternas Ecoline com lente lisa	Amarelo	01
PL0650.72.03	Conjunto com 05 lanternas Ecoline com lente lisa	Vermelho	01

CÓDIGO	DESCRIÇÃO	COR	EMB.
PL0650.52.01	Conjunto com 05 lanternas Ecoline com lente bojuda	Amarelo	01
PL0650.52.03	Conjunto com 05 lanternas Ecoline com lente bojuda	Vermelho	01



PL 9900

Soquete com 1 polo
Aplicação universal



CÓDIGO DESCRIÇÃO
PL9900 .17.94 Soquete com 1 polo universal

SOQUETE LED Disponível

Saiba mais na página 23

Para lâmpadas

- P21W - Freio
- P21W - Luz de Ré
- P21W - Direcional
- R5W - Posição

PL 9901

Soquete com 2 polos
Aplicação universal



CÓDIGO DESCRIÇÃO
PL9901 .37.94 Soquete com 2 polos universal

SOQUETE LED Disponível

Saiba mais na página 23

Para lâmpadas

- P21/5W Freio e Posição
- P21/5W Direcional e Posição

PL 9906

Chicote com soquete de 1 polo
Aplicação VW para lanternas PL0696 e PL0698

Para lâmpadas



W5W - Posição

R5W - Posição

CÓDIGO DESCRIÇÃO EMB.
PL9906 .17.00 Chicote com soquete de 1 polo tipo VW 10

PL 9911

Chicote com soquete de 1 polo
Aplicação universal ônibus para lanternas PL0438 e PL0706



R5W - Posição

CÓDIGO DESCRIÇÃO EMB.
PL9911 .17.97 Chicote com soquete de 1 polo tipo ônibus 10

PL 9913

Soquete com 1 polo
Aplicação universal para lanternas PL0426, PL0442, PL0470, PL0598 e PL1316



Para lâmpadas

T4W - Posição

CÓDIGO REF. ORIGINAL EMB.
PL9913 .17.97 MB 345.544.01.93 - VL 344-130 20

PL 9914

Soquete com 1 polo
Aplicação universal e VW para lanterna PL0598

Para lâmpadas



P21W - Direcional

PY21W - Direcional

CÓDIGO DESCRIÇÃO EMB.
PL9914 .17.96 Soquete com 1 polo universal e VW 20

REPOSIÇÃO EMB.
PL9994 .17.97 Chicote com conector 2 vias 10

PL 9916

Chicote com soquete de 1 polo tipo cachimbo
Aplicação MB e universal para lanterna PL0520

Para lâmpadas



P21W - Freio

P21W - Luz de Ré

P21W - Direcional

R5W - Posição

CÓDIGO DESCRIÇÃO EMB.
PL9916 .17.94 Chicote com soquete de 1 polo tipo cachimbo MB e universal 10

PL 9917

Chicote com soquete de 2 polos tipo cachimbo
Aplicação MB e universal para lanternas PL0466, PL0476 e PL0520

Para lâmpadas



P21W - Direcional

P21/5W Direcional e Posição

CÓDIGO DESCRIÇÃO EMB.
PL9917 .37.94 Chicote com soquete de 2 polos tipo cachimbo MB e universal 10

PL 9918

Soquete com 1 polo em nylon
Aplicação IV para lanternas PL0722, PL0732 e PL0738



Para lâmpadas

P21W - Direcional

CÓDIGO DESCRIÇÃO EMB.
PL9918 .17.96 Soquete com 1 polo em nylon tipo IV 10

PL 9919

Soquete com 2 polos em nylon
Aplicação VL para lanterna PL1708



Para lâmpadas

P21/5W Direcional e Posição

CÓDIGO DESCRIÇÃO EMB.
PL9919 .37.94 Soquete com 2 polos em nylon tipo VL 10

PL 9920

Soquete com 1 polo em nylon
Aplicação VL para lanterna PL1704



Para lâmpadas

P21W - Direcional

CÓDIGO DESCRIÇÃO EMB.
PL9920 .17.97 Soquete em nylon tipo VL 20

PL 9921

Soquete com 1 polo em nylon
Aplicação VL para lanterna PL0708



Para lâmpadas

P21W - Direcional

CÓDIGO DESCRIÇÃO EMB.
PL9921 .17.97 Soquete em nylon tipo VL 10

PL 9922

Soquete com 1 polo em nylon
Aplicação MB para lanternas PL0588 e PL0592



Para lâmpadas

PY21W - Direcional

CÓDIGO DESCRIÇÃO EMB.
PL9922 .17.96 Soquete em nylon tipo MB 10

PL 9924

Soquete com 1 polo em nylon
Aplicação VW para função posição da lanterna PL0896



Para lâmpadas

W5W - Posição

CÓDIGO REF. ORIGINAL EMB.
PL9924 .17.96 VW 547 953 055-0 20

REPOSIÇÃO EMB.
PL9996 .17.97 Chicote com conector 2 vias 10



SOQUETES

PL 9926

Soquete com 1 polo em nylon
Aplicação VW para função direcional
da lanterna PL0896



Para lâmpadas



P21W - Direcional



PY21W - Direcional

CÓDIGO REF. ORIGINAL EMB.
PL9926 .17.94 GM 90 444 711 10

PL 9928

Soquete com 1 polo em nylon
Aplicação VW para função posição
das lanternas PL0730 e PL0986



Para lâmpadas



W5W - Posição

CÓDIGO REF. ORIGINAL EMB.
PL9928 .17.97 90 443 393 20

PL 9929

Soquete com 1 polo em nylon
Aplicação SC para faróis PL6012 e PL6014



Para lâmpadas

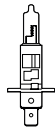

H1 - Farol

CÓDIGO DESCRIÇÃO EMB.
PL9929 .17.97 Soquete em nylon tipo SC para farol 10

PL 9930

Soquete com 1 polo em nylon
Aplicação VW para função direcional
da lanterna PL0986



Para lâmpadas



PY21W - Direcional

CÓDIGO DESCRIÇÃO EMB.
PL9930 .17.97 Soquete em nylon tipo VW para direcional 10

PL 9931

Chicote com soquete 2 polos
Aplicação em lanternas PL0612



Para lâmpadas



P21W - Posição

CÓDIGO DESCRIÇÃO EMB.
PL9931 .37.97 Chicote com conector e soquete 2 polos 01

PL 9932

Soquete com 1 polo em nylon
Aplicação VL para lanternas PL0740 e PL1710



Para lâmpadas



R5W - Posição

CÓDIGO DESCRIÇÃO EMB.
PL9932 .17.94 Soquete com 1 polo em nylon tipo VL 10

PL 9934

Soquete com 1 polo em nylon
Aplicação Ford para lanternas PL0494 e PL0496



Para lâmpadas



PY21W - Direcional

CÓDIGO DESCRIÇÃO EMB.
PL9934 .17.95 Soquete com 1 polo em nylon tipo Ford 10

PL 9936

Chicote com soquete de 1 polo tipo cachimbo e terminal
Aplicação Ford para lanterna PL0434



Para lâmpadas



PY21W Direcional

CÓDIGO DESCRIÇÃO EMB.
PL9936 .17.94 Chicote com soquete de 1 polo tipo cachimbo e terminal tipo Ford 10

PL 9946

Chicote universal com conector ultra seal 2 vias
Aplicação universal



PL9946.41.00

CÓDIGO DESCRIÇÃO EMB.
PL9946 .17.00 Conector ultra seal 2 vias 10
PL9946 .41.00 Conector ultra seal 2 vias e Faston 10

PL 9947

Chicote 7 vias fêmea com 20cm de cabos
Aplicação lanternas PL0728, PL0916, PL1442, PL1550, PL1616, PL1618 e PL1702



REPOSIÇÃO REF. ORIGINAL EMB.
PL9947 .39.00 3963412 10

PL 9948

Chicote 2 vias com guarda pó para Faston 6,3mm
Aplicação lanternas laterais



CÓDIGO DESCRIÇÃO EMB.
PL9948 .17.00 Chicote 2 vias com guarda pó 10

PL 9950

Chicote 2 vias com guarda pó para Faston 6,3mm
Aplicação lanternas com módulos LEDs



CÓDIGO DESCRIÇÃO EMB.
PL9950 .17.00 Chicote 2 vias com guarda pó 10

PL 9951

Chicote 3 vias com guarda pó para Faston 6,3mm
Aplicação lanternas com módulos LEDs



CÓDIGO DESCRIÇÃO EMB.
PL9951 .37.00 Chicote 3 vias com guarda pó 10

PL 9952

Chicote completo
Aplicação lanterna PL0826



Para lâmpadas



2 lâmpadas P21W - Direcional Luz de ré



P21/5W Freio e Posição

CÓDIGO DESCRIÇÃO EMB.
PL9952 .41.00 Chicote completo 10

PL 9953

Chicote com conector ultra seal 5 vias
Aplicação universal



CÓDIGO DESCRIÇÃO EMB.
PL9953 .39.00 Chicote com conector ultra seal 5 vias e conector Faston 6,3mm 10



PL 9954

Chicote com 4 soquetes e conector
Aplicação lanterna PL1446



Para lâmpadas



2 lâmpadas
P21W - Direcional



2 lâmpadas
R5W - Posição

CÓDIGO	DESCRIÇÃO	EMB.
PL9954 .17.00	Chicote com 4 soq. padrão Hella	05

PL 9955

Soquetes com 1 polo
Aplicação SC para lanterna PL0478



Para lâmpada



P21W - Direcional

CÓDIGO	DESCRIÇÃO	EMB.
PL9955 .17.00	Soquete com 1 polo tipo SC	10

PL 9956

Soquete em nylon
Aplicação MB para lanternas PL0348 e PL0498



PRADOLUX®
Produto
Exclusivo

Para lâmpada



PY21W - Direcional

CÓDIGO	DESCRIÇÃO	EMB.
PL9956 .17.97	Soquete em nylon tipo MB Direcional	10

PL 9958

Soquete 1 polo em nylon
Aplicação MB para direcional



Para lâmpadas



P21W - Posição

CÓDIGO	DESCRIÇÃO	EMB.
PL9958 .17.00	Soquete 1 polo em nylon tipo MB Direcional	10

PL 9983

Chicote com conector 6 vias - Macho
Aplicação lanterna PL0482



CÓDIGO	DESCRIÇÃO	EMB.
PL9983 .00.00	Chicote conector 6 vias - Macho	10

PL 9984

Chicote conector
Aplicação suporte traseiro PL2600



PL9984.42.13
Lado esquerdo

PL9984.41.12
Lado direito

CÓDIGO	LADO	EMB.
PL9984 .42.13	Lado esquerdo	10
PL9984 .41.12	Lado direito	10

PL 9985

Chicote com conector 6 vias - Fêmea
Aplicação lanterna PL0482



CÓDIGO	DESCRIÇÃO	EMB.
PL9985 .00.00	Chicote conector 6 vias - Fêmea	10

PL 9986

Chicote com conector 7 vias
Aplicação lanterna PL0912



CÓDIGO	DESCRIÇÃO	EMB.
PL9986 .00.97	Chicote com conector 7 vias	10

PL 9987

Chicote completo para farol
Aplicação farol PL7028



CÓDIGO	DESCRIÇÃO	EMB.
PL9987 .41.00	Chicote completo para farol	10

PL 9988

Chicote com conector 6 vias
Aplicação lanterna PL1444



CÓDIGO	DESCRIÇÃO	EMB.
PL9988 .00.97	Chicote com conector 6 vias SC	10

PL 9990

Chicote com conector 8 vias
Aplicação lanterna PL1620



CÓDIGO	DESCRIÇÃO	EMB.
PL9990 .00.97	Chicote com conector 8 vias DAF	10

PL 9991

Chicote completo
Aplicação lanterna PL0828

Para lâmpadas



2 lâmpadas
P21W - Direcional
Luz de ré



P21/5W
Freio e Posição

CÓDIGO	DESCRIÇÃO	EMB.
PL9991 .41.00	Chicote completo	10

PL 9994

Chicote com conector 2 vias
Aplicação lanterna PL0576



CÓDIGO	DESCRIÇÃO	EMB.
PL9994 .17.97	Chicote com conector 2 vias	10

PL 9995

Chicote com conector 3 vias
Aplicação lanterna PL0474



CÓDIGO	DESCRIÇÃO	EMB.
PL9995 .37.97	Chicote com conector 3 vias	10

PL 9996

Chicote com conector 2 vias
Aplicação lanternas PL0448, PL0518 e PL0896



CÓDIGO	DESCRIÇÃO	EMB.
PL9996 .17.97	Chicote com conector 2 vias	10

PL 9997

Chicote com conector ultra seal 3 vias
Aplicação lanterna PL0996



CÓDIGO	DESCRIÇÃO	EMB.
PL9997 .37.97	Chicote com conector ultra seal 3 vias	10

PL 9998

Chicote com conector 2 vias
Aplicação lanternas PL0454, PL0486, PL0492,
PL0714, PL0744, PL0746 e PL0750



CÓDIGO	DESCRIÇÃO	EMB.
PL9998 .17.97	Chicote com conector 2 vias	10

PL 9999

Chicote com conector 5 vias fêmea
Aplicação lanternas PL0716



CÓDIGO	DESCRIÇÃO	EMB.
PL9999 .17.97	Chicote com conector 5 vias fêmea	10



SOQUETES

PL 9100

Cabo elétrico 1 via 0,50mm com 50m



CÓDIGO	COR	EMB.
PL9100.00.50	Preto	01 Rolo
PL9100.10.50	Branco	01 Rolo
PL9100.20.50	Vermelho	01 Rolo
PL9100.30.50	Verde	01 Rolo
PL9100.40.50	Azul	01 Rolo
PL9100.50.50	Amarelo	01 Rolo
PL9100.60.50	Marrom	01 Rolo

PL 9101

Cabo elétrico 1 via 0,75mm com 50m



CÓDIGO	COR	EMB.
PL9101.00.50	Preto	01 Rolo
PL9101.10.50	Branco	01 Rolo
PL9101.20.50	Vermelho	01 Rolo
PL9101.30.50	Verde	01 Rolo
PL9101.40.50	Azul	01 Rolo
PL9101.50.50	Amarelo	01 Rolo
PL9101.60.50	Marrom	01 Rolo

PL 9102

Cabo elétrico quadrado 2 vias



CÓDIGO	BITOLA	COMPRIMENTO	EMB.
PL9102.00.50	0,75mm	50M	01 Rolo
PL9102.02.00	0,75mm	200M	01 Rolo

PL 9103

Cabo elétrico com 50m



CÓDIGO	BITOLA	EMB.
PL9103.00.50	1mm	01 Rolo

PL 9104

Cabo elétrico 2 vias com 50m



CÓDIGO	BITOLA	EMB.
PL9104.00.50	1mm	01 Rolo

PL 9105

Cabo elétrico com 50m



CÓDIGO	BITOLA	EMB.
PL9105.00.50	1,5mm	01 Rolo

PL 9106

Cabo elétrico 2 vias com 50m



CÓDIGO	BITOLA	EMB.
PL9106.00.50	1,5mm	01 Rolo

PL 9107

Cabo elétrico 3 vias com 50m



CÓDIGO	BITOLA	EMB.
PL9107.00.50	0,50mm	01 Rolo

PL 9108

Cabo elétrico 5 vias com 1m



CÓDIGO	BITOLA	EMB.
PL9108.00.50	0,50mm	01 Rolo

PL 9109

Cabo elétrico 7 vias com 1m



CÓDIGO	BITOLA	EMB.
PL9109.00.50	0,50mm	01 Rolo

PL 9200

Terminal fêmea em latão



CÓDIGO	TAMANHO	EMB.
PL9200.00.00	6,3mm	50

PL 9201

Terminal macho em latão



CÓDIGO	TAMANHO	EMB.
PL9201.00.00	6,3mm	50

PL 9202

Capa para terminal fêmea



CÓDIGO	TAMANHO	EMB.
PL9202.00.00	6,3mm	50

PL 9203

Capa para terminal macho



CÓDIGO	TAMANHO	EMB.
PL9203.00.00	6,3mm	50

PL 9204

Derivador 2 vias para fio redondo 0,5mm² a 1,5mm²



CÓDIGO	DESCRIÇÃO	EMB.
PL9204.00.00	Derivador 2 vias para fio redondo 0,5mm ² a 1,5mm ²	50

PL 9205

Derivador Double Click para cabo ret. 2 x 0,75mm²



CÓDIGO	DESCRIÇÃO	EMB.
PL9205.00.00	Derivador Double Click para cabo ret. 2 mm ² a 0,75mm ²	50

Veja como ficou a construção do layout de exibição do produto no catálogo

CÓDIGO DA SÉRIE ← **PL 0494**
 NOME DO PRODUTO ← **Lanterna direcional**
 Aplicação Ford Cargo traçado frente horizontal

PRODUTO DE COR OU VERSÃO PADRÃO E COM MAIOR DESTAQUE DE VENDAS ← 

OUTRAS DISPONIBILIDADES DE CORES OU VERSÕES DO PRODUTO → 

CÓDIGO COMPLETO DO PRODUTO ← **PL0494.00.22** **PL0494.41.22**

ITENS DE REPOSIÇÃO PARA O PRODUTO ← 

Vista lateral  → MODELO DA LÂMPADA UTILIZADA NO PRODUTO

CÓDIGO	DESCRIÇÃO	LENTE	COR	REF. ORIGINAL	EMB.
PL0494.00.22	Sem soquete	Polycarbonato	Cristal	-	06
PL0494.41.22	Com soquete	Polycarbonato	Cristal	4C46/13368/CA	06
PL9934.17.95	Soquete com 1 polo em nylon tipo Ford				10

DESTAQUES DE VENDAS ← **PL0494.00.22** Sem soquete Polycarbonato Cristal - 06 → QUANTIDADE DE PRODUTOS POR EMBALAGEM

CÓDIGO COMPLETO DO PRODUTO ← **PL0494.41.22** Com soquete Polycarbonato Cristal 4C46/13368/CA 06 → REFERÊNCIA ORIGINAL DO PRODUTO

CÓDIGO COMPLETO DA REPOSIÇÃO DO PRODUTO ← **PL9934.17.95** Soquete com 1 polo em nylon tipo Ford 10

Tabela 01 - Versões

00	Sem definição / LED bivolt	25	Lente lisa com vigia lado dir.	50	Com fios / chicote - lado esq. / com vigia	75	Suporte com triângulo e ré LED lado dir.
01	Lado direito / Sem vigia	26	Lente lisa com vigia lado esq.	51		76	Suporte com triângulo e ré LED lado esq.
02	Lado esquerdo / Com vigia	27	Lente lisa com moldura	52	Suporte e lente bojuda com 5un	77	Suporte com ré LED lado dir.
03	Com cúpula	28	Lente lisa com moldura lado esq.	53	Suporte e lente bojuda com 3un	78	Suporte com ré LED lado esq.
04	Com cúpula lado esq.	29	Borda redonda	54	Suporte e lente bojuda com 4un	79	Suporte nova versão lado dir.
05	Com cúpula e vigia	30	Base reta e haste	55		80	Suporte nova versão lado esq.
06	Com cúpula e vigia lado esq.	31	Nova versão com soquete / conector sem vigia	56		81	Com aro preto
07	Com moldura	32	Nova versão com soquete / conector com vigia	57	Suporte bivolt - lado dir.	82	Com aro preto 1 polo / com interruptor
08	Com moldura lado esq.	33	Lado direito 24V	58	Suporte bivolt - lado esq.	83	Com aro preto 2 polos
09	Tipo bolha sem vigia	34	Lado esquerdo 24V	59	Bilateral nova versão	84	Com aro cromado
10	Tipo bolha com vigia	35	Base curva	60	Bilateral	85	Com aro cromado 1 polo / com interruptor
11	Com refletivo lado dir. / LED 12V	36	Base curva lado esq.	61	Suporte lado direito	86	Com aro cromado 2 polos
12	Com refletivo lado esq. / LED 12V	37	Com 2 polos	62	Suporte lado esq.	87	Com grade preta
13	Com adaptação	38	Com 2 polos lado esq.	63	Suporte com aba lado dir.	88	Com grade cromada
14	Com adaptação lado esq.	39	Com 1 polo nova versão	64	Suporte com aba lado esq.	89	Com grade preta nova versão
15	Base reta	40	Lente menor	65	Suporte com triângulo lado dir.	90	Com grade cromada nova versão
16	Base reta lado esq.	41	Com soquete / conector	66	Suporte com triângulo lado esq.	91	
17	Com 1 polo	42	Com soquete / conector lado esq.	67	Suporte com refletor lado dir.	92	
18	Com 1 polo lado esq.	43	Com soquete e cúpula	68	Suporte com refletor lado esq.	93	
19	Com haste / Suporte	44	Com soquete e cúpula lado esq.	69	Suporte com 2 faces	94	
20	Com interruptor	45	Com vigia	70	Suporte com 3un	95	
21	Nova versão sem vigia	46		71	Suporte com 4un	96	
22	Nova versão com vigia	47	Com soquete 7 vias LD	72	Suporte com 5un	97	
23	Lente lisa sem vigia	48	Com soquete 7 vias LE	73	Suporte com aba e ré LED lado dir.	98	
24	Lente lisa com vigia / LED 24V	49	Com fios / chicote - lado direito / sem vigia	74	Suporte com aba e ré LED lado esq.	99	

Tabela 02 - Material / LED / Cores

De 01 à 19 Plástico básico		De 20 à 39 Em acrílico		De 40 à 59 LED - Plástico básico		De 60 à 79 LED - Acrílico		De 80 à 99	
AM	00 sem definição	20		40		60		80	Lâmpada 12v
AM	01 Amarelo	21	Amarelo	41	Amarelo	61	Amarelo	81	Lâmpada 12v 100w
CR	02 Cristal	22	Cristal	42	Cristal	62	Cristal	82	Lâmpada 24v
VM	03 Vermelho	23	Vermelho	43	Vermelho	63	Vermelho	83	
FM	04 Fumê	24	Fumê	44	Fumê	64	Fumê	84	
BIC	05 Vermelho e Amarelo	25	Vermelho e Amarelo	45	Vermelho e Amarelo	65	Vermelho e Amarelo	85	
AMCR	06 Amarelo e Cristal	26	Amarelo e Cristal	46	Amarelo e Cristal	66	Amarelo e Cristal	86	
VMCR	07 Vermelho e Cristal	27	Vermelho e Cristal	47	Vermelho e Cristal	67	Vermelho e Cristal	87	
VMFM	08 Vermelho e Fumê	28	Vermelho e Fumê	48	Vermelho e Fumê	68	Vermelho e Fumê	88	
TRI	09 Tricolor VM / AM / CR	29	Tricolor VM / AM / CR	49	Tricolor VM / AM / CR	69	Tricolor VM / AM / CR	89	
TRI	10 Tricolor VM / AM / FU	30	Tricolor VM / AM / FU	50	Tricolor VM / AM / FU	70	Tricolor VM / AM / FU	90	
AZ	11 Azul ou VM / AZ	31	Azul ou VM / AZ	51	Azul ou VM / AZ	71	Azul ou VM / AZ	91	
VD	12 Verde	32	Verde	52	Verde	72	Verde	92	
AL	13 Amarelo Fosco	33	Amarelo Fosco	53	Amarelo Fosco	73	Amarelo Fosco	93	
BR	14 Branco	34	Branco	54	Branco	74	Branco	94	Soquete branco
AMPT	15 Amarelo e Preto	35	Amarelo e Cinza	55	Amarelo e Preto	75	Amarelo e Preto	95	Soquete zincado / LA
ALU	16 Alumínio / Cromado	36	Alumínio / Cromado	56	Alumínio / Cromado	76	Alumínio / Cromado	96	Soquete cinza
PT	17 Preto	37	Preto	57	Preto	77	Preto	97	Soquete preto
REF	18 Refletor	38	Refletor	58	Refletor	78	Refletor	98	
MET	19 Metalizado	39	Metalizado	59	Metalizado	79	Metalizado	99	



PRADOLUX®

Tabela de códigos

CÓDIGO NOVO	PÁG.	CÓDIGO NOVO	PÁG.	CÓDIGO NOVO	PÁG.	CÓDIGO NOVO	PÁG.	CÓDIGO NOVO	PÁG.		
PL0130.00.01	95	PL0420.00.01	40	PL0448.24.01	52	PL0480.00.56	32	PL0520.01.01	54	PL0564.00.02	27
PL0130.00.02	95	PL0422.01.09	87	PL0448.24.02	52	PL0481.00.01	32	PL0520.02.01	54	PL0564.00.03	27
PL0130.00.03	95	PL0422.02.09	87	PL0448.25.01	52	PL0481.00.02	32	PL0520.03.02	54	PL0564.00.41	27
PL0140.00.01	95	PL0423.01.09	87	PL0448.25.02	52	PL0481.00.03	32	PL0520.04.02	54	PL0564.00.42	27
PL0140.00.02	95	PL0423.02.09	87	PL0448.26.01	52	PL0481.00.16	32	PL0524.15.41	24	PL0564.00.43	27
PL0140.00.03	95	PL0424.01.01	88	PL0448.26.02	52	PL0482.21.07	73	PL0524.15.42	24	PL0564.15.41	27
PL0150.00.01	95	PL0424.02.01	88	PL0448.45.01	52	PL0482.21.27	73	PL0524.15.43	24	PL0564.15.42	27
PL0150.00.02	95	PL0424.03.02	88	PL0448.46.01	52	PL0482.21.47	73	PL0524.19.01	24	PL0564.15.43	27
PL0150.00.03	95	PL0424.04.02	88	PL0450.00.01	53	PL0482.22.07	73	PL0524.19.02	24	PL0565.00.01	27
PL0152.24.41	95	PL0426.21.01	36	PL0450.00.02	53	PL0482.22.27	73	PL0524.19.03	24	PL0565.00.02	27
PL0152.24.42	95	PL0426.21.02	36	PL0451.00.01	53	PL0482.22.47	73	PL0524.19.17	24	PL0565.00.03	27
PL0152.24.43	95	PL0426.21.41	36	PL0451.00.02	53	PL0482.49.07	73	PL0524.19.41	24	PL0566.15.41	27
PL0270.00.02	37	PL0426.21.42	36	PL0452.00.01	93	PL0482.50.07	73	PL0524.19.42	24	PL0566.15.42	27
PL0270.00.42	37	PL0426.31.01	36	PL0452.00.02	93	PL0483.21.07	73	PL0524.19.43	24	PL0566.15.43	27
PL0301.00.02	40	PL0426.31.02	36	PL0452.00.03	93	PL0483.21.27	73	PL0525.00.01	96	PL0566.19.01	27
PL0306.00.16	40	PL0428.20.14	57	PL0452.00.41	93	PL0484.00.01	63	PL0525.00.02	96	PL0566.19.02	27
PL0306.00.17	40	PL0429.00.14	57	PL0452.00.42	93	PL0484.00.41	63	PL0525.00.03	96	PL0566.19.03	27
PL0306.82.02	40	PL0429.20.14	57	PL0452.00.43	93	PL0486.00.62	79	PL0525.21.01	96	PL0566.19.41	27
PL0306.83.02	40	PL0434.01.01	35	PL0452.29.01	93	PL0488.01.22	88	PL0525.21.03	96	PL0566.19.42	27
PL0306.85.02	40	PL0434.02.01	35	PL0452.29.02	93	PL0488.02.22	88	PL0526.00.01	23	PL0566.19.43	27
PL0306.86.02	40	PL0434.03.02	35	PL0452.29.03	93	PL0490.01.29	88	PL0526.00.02	23	PL0570.21.05	18
PL0307.00.03	87	PL0434.04.02	35	PL0452.29.41	93	PL0490.02.29	88	PL0526.00.03	23	PL0571.21.05	18
PL0312.00.61	24	PL0434.23.02	35	PL0452.29.42	93	PL0490.21.27	88	PL0526.15.41	24	PL0572.00.01	69
PL0312.00.62	24	PL0434.23.22	35	PL0452.29.43	93	PL0490.22.27	88	PL0526.15.42	24	PL0572.41.01	69
PL0312.00.63	24	PL0434.24.02	35	PL0453.00.01	93	PL0492.24.61	55	PL0526.15.43	24	PL0573.00.01	69
PL0312.00.72	24	PL0434.24.22	35	PL0453.00.02	93	PL0494.00.22	36	PL0526.21.01	24	PL0574.01.22	54
PL0326.00.01	26	PL0436.01.29	89	PL0453.00.03	93	PL0494.41.22	36	PL0526.21.02	24	PL0574.02.22	54
PL0326.00.02	26	PL0436.02.29	89	PL0453.29.01	93	PL0496.00.22	36	PL0526.21.03	24	PL0576.01.21	54
PL0326.00.03	26	PL0438.00.02	63	PL0453.29.02	93	PL0496.41.22	36	PL0526.21.41	24	PL0576.01.22	54
PL0326.19.01	26	PL0440.01.07	38	PL0453.29.03	93	PL0498.01.22	53	PL0526.21.42	24	PL0576.02.21	54
PL0326.19.02	26	PL0440.01.09	38	PL0456.29.01	93	PL0498.02.22	53	PL0526.21.43	24	PL0576.02.22	54
PL0326.19.03	26	PL0440.01.29	38	PL0458.00.01	93	PL0500.01.05	57	PL0528.01.01	54	PL0577.01.21	54
PL0327.00.01	26	PL0440.02.07	38	PL0458.29.01	93	PL0500.02.05	57	PL0528.01.02	54	PL0577.01.22	54
PL0327.00.02	26	PL0440.02.09	38	PL0460.01.02	35	PL0501.00.05	57	PL0528.02.01	54	PL0577.02.21	54
PL0327.00.03	26	PL0440.02.29	38	PL0460.02.02	35	PL0502.00.05	91	PL0528.02.02	54	PL0577.02.22	54
PL0348.03.22	51	PL0440.21.49	38	PL0460.21.02	35	PL0503.00.05	91	PL0530.24.61	69	PL0578.00.61	25
PL0348.04.22	51	PL0440.22.49	38	PL0460.22.02	35	PL0506.00.01	94	PL0531.00.01	24	PL0578.00.62	25
PL0400.31.27	89	PL0440.23.09	38	PL0462.01.02	37	PL0507.00.01	94	PL0531.00.02	24	PL0578.00.63	25
PL0400.32.27	89	PL0440.23.49	38	PL0462.01.42	37	PL0508.81.05	94	PL0531.00.03	24	PL0578.00.72	25
PL0400.49.27	89	PL0440.24.09	38	PL0462.02.02	37	PL0509.00.05	94	PL0532.00.07	55	PL0580.00.22	55
PL0400.50.27	89	PL0440.24.49	38	PL0462.02.42	37	PL0510.15.01	56	PL0533.00.02	55	PL0580.00.62	55
PL0402.01.29	87	PL0441.00.07	38	PL0462.15.02	37	PL0510.15.02	56	PL0533.00.03	55	PL0582.00.01	22
PL0402.02.29	87	PL0441.00.09	38	PL0462.15.42	37	PL0510.35.01	63	PL0534.00.01	69	PL0582.00.02	22
PL0404.60.01	94	PL0441.00.29	38	PL0462.21.02	37	PL0511.00.01	56	PL0534.03.02	69	PL0582.00.23	22
PL0404.60.03	94	PL0441.23.09	38	PL0462.22.02	37	PL0511.00.02	56	PL0535.00.01	69	PL0584.19.17	25
PL0404.69.05	94	PL0442.00.02	70	PL0462.35.02	37	PL0512.81.01	95	PL0535.00.02	69	PL0584.19.61	25
PL0405.00.01	94	PL0442.00.42	70	PL0462.36.02	37	PL0512.81.02	95	PL0536.00.01	23	PL0584.19.62	25
PL0405.00.03	94	PL0444.00.14	63	PL0464.00.01	34	PL0512.81.03	95	PL0536.00.02	23	PL0584.19.63	25
PL0406.00.05	36	PL0446.01.06	61	PL0464.00.02	34	PL0512.81.17	95	PL0536.00.03	23	PL0584.19.72	25
PL0406.37.05	36	PL0446.02.06	61	PL0464.00.13	34	PL0512.81.41	95	PL0540.00.07	63	PL0586.00.01	23
PL0408.21.01	50	PL0446.11.04	61	PL0466.00.21	50	PL0512.81.42	95	PL0542.00.05	91	PL0586.00.02	23
PL0408.35.05	50	PL0446.11.06	61	PL0466.00.22	50	PL0512.81.43	95	PL0543.00.05	91	PL0586.00.03	23
PL0408.36.05	50	PL0446.12.04	61	PL0466.41.21	50	PL0512.87.01	95	PL0544.00.17	32	PL0588.01.02	55
PL0409.00.01	50	PL0446.12.06	61	PL0468.01.29	87	PL0512.87.02	95	PL0544.00.57	32	PL0588.01.22	55
PL0409.00.02	50	PL0447.01.06	61	PL0468.02.29	87	PL0512.87.03	95	PL0547.01.01	71	PL0588.02.02	55
PL0410.15.01	50	PL0447.02.06	61	PL0470.00.02	37	PL0512.87.12	95	PL0547.02.01	71	PL0588.02.22	55
PL0410.15.02	50	PL0447.11.04	61	PL0470.00.42	37	PL0512.87.41	95	PL0548.01.01	53	PL0590.81.02	86
PL0410.15.05	50	PL0447.11.06	61	PL0470.41.02	37	PL0514.00.01	53	PL0548.02.01	53	PL0592.01.02	55
PL0410.17.01	90	PL0447.12.04	61	PL0474.01.21	35	PL0514.00.02	53	PL0552.00.01	94	PL0592.02.02	55
PL0410.18.01	90	PL0447.12.06	61	PL0474.02.21	35	PL0515.00.01	53	PL0552.00.02	94	PL0592.41.02	55
PL0410.37.01	90	PL0448.01.01	52	PL0474.33.41	35	PL0515.00.02	53	PL0552.00.03	94	PL0592.42.02	55
PL0410.38.01	90	PL0448.02.01	52	PL0474.34.41	35	PL0516.01.05	57	PL0553.00.01	94	PL0593.00.01	95
PL0412.41.61	24	PL0448.03.02	52	PL0476.00.22	51	PL0516.01.09	57	PL0553.00.02	94	PL0593.00.02	95
PL0412.41.62	24	PL0448.03.04	52	PL0476.00.35	51	PL0516.02.05	57	PL0553.00.03	94	PL0593.00.03	95
PL0412.41.63	24	PL0448.04.02	52	PL0476.41.35	51	PL0516.02.09	57	PL0554.00.01	70	PL0593.00.12	95
PL0412.41.72	24	PL0448.04.04	52	PL0478.00.21	62	PL0516.21.09	90	PL0554.00.02	70	PL0594.00.01	56
PL0414.00.01	94	PL0448.05.02	52	PL0478.41.21	62	PL0516.22.09	90	PL0555.00.02	70	PL0594.00.02	56
PL0414.00.02	94	PL0448.05.04	52	PL0480.00.01	32	PL0517.00.05	57	PL0558.00.01	23	PL0595.00.01	56
PL0418.00.01	94	PL0448.06.02	52	PL0480.00.02	32	PL0517.00.09	57	PL0558.00.02	23	PL0595.00.02	56
PL0418.00.02	94	PL0448.06.04	52	PL0480.00.03	32	PL0517.21.09	90	PL0558.00.03	23	PL0598.00.21	68
PL0418.00.03	94	PL0448.07.14	52	PL0480.00.16	32	PL0518.01.01	51	PL0562.00.01	23	PL0598.00.22	68
PL0419.00.01	94	PL0448.08.14	52	PL0480.00.41	32	PL0518.02.01	51	PL0562.00.02	23	PL0598.00.61	68
PL0419.00.02	94	PL0448.23.01	52	PL0480.00.42	32	PL0518.03.02	51	PL0562.00.23	23	PL0598.00.62	68
PL0419.00.03	94	PL0448.23.02	52	PL0480.00.43	32	PL0518.04.02	51	PL0564.00.01	27	PL0598.13.21	68

Tabela de códigos

CÓDIGO NOVO	PÁG.	CÓDIGO NOVO	PÁG.	CÓDIGO NOVO	PÁG.	CÓDIGO NOVO	PÁG.	CÓDIGO NOVO	PÁG.		
PL0598.13.22	68	PL0616.22.13	27	PL0696.02.01	71	PL0731.00.23	19	PL0808.24.67	20	PL0904.19.23	31
PL0598.41.21	68	PL0617.01.13	27	PL0696.02.02	71	PL0732.01.01	43	PL0818.00.65	20	PL0904.19.32	31
PL0598.41.22	68	PL0617.02.13	27	PL0696.21.01	71	PL0732.01.02	43	PL0818.00.67	20	PL0904.19.61	31
PL0599.00.01	92	PL0617.21.13	27	PL0696.22.01	71	PL0732.02.01	43	PL0818.00.69	20	PL0904.19.62	31
PL0599.00.02	92	PL0617.22.13	27	PL0696.41.01	71	PL0732.02.02	43	PL0820.00.65	20	PL0904.19.63	31
PL0599.00.03	92	PL0638.41.41	26	PL0696.42.01	71	PL0734.01.21	42	PL0820.00.67	20	PL0904.19.72	31
PL0599.21.01	92	PL0638.41.42	26	PL0698.00.01	71	PL0734.02.21	42	PL0820.00.69	20	PL0904.46.21	31
PL0599.21.02	92	PL0638.41.43	26	PL0698.00.02	71	PL0734.01.22	42	PL0820.21.65	20	PL0904.46.22	31
PL0599.21.03	92	PL0640.00.61	29	PL0698.21.01	71	PL0734.02.22	42	PL0820.21.67	20	PL0904.46.23	31
PL0599.29.01	92	PL0640.00.62	29	PL0698.41.01	71	PL0736.41.07	44	PL0820.21.69	20	PL0904.46.32	31
PL0599.29.02	92	PL0640.00.63	29	PL0700.01.06	76	PL0736.42.07	44	PL0826.01.29	40	PL0904.46.61	31
PL0599.29.03	92	PL0640.00.66	29	PL0700.02.06	76	PL0737.00.07	44	PL0826.02.29	40	PL0904.46.62	31
PL0600.00.01	92	PL0640.41.61	29	PL0701.01.06	76	PL0738.01.22	42	PL0826.41.29	40	PL0904.46.63	31
PL0600.00.02	92	PL0640.41.62	29	PL0701.02.06	76	PL0738.02.22	42	PL0826.42.29	40	PL0904.46.72	31
PL0600.00.03	92	PL0640.41.63	29	PL0702.13.09	81	PL0740.00.21	76	PL0828.00.27	40	PL0905.00.21	31
PL0600.20.02	92	PL0640.41.66	29	PL0702.14.09	81	PL0740.00.22	76	PL0828.49.27	40	PL0905.00.22	31
PL0600.21.01	92	PL0642.00.61	29	PL0703.00.09	81	PL0742.41.62	43	PL0830.01.29	41	PL0905.00.23	31
PL0600.21.02	92	PL0642.00.62	29	PL0704.00.01	77	PL0742.42.62	43	PL0830.02.29	41	PL0905.00.32	31
PL0600.21.03	92	PL0642.00.63	29	PL0704.00.41	77	PL0744.33.62	77	PL0831.00.29	41	PL0905.21.21	31
PL0600.29.01	92	PL0642.00.66	29	PL0704.31.01	77	PL0744.34.62	77	PL0886.00.00	08	PL0905.21.22	31
PL0600.29.02	92	PL0642.41.61	29	PL0705.41.01	77	PL0746.24.61	78	PL0886.11.67	08	PL0905.21.23	31
PL0600.29.03	92	PL0642.41.62	29	PL0705.00.01	77	PL0748.00.61	43	PL0886.12.67	08	PL0905.21.32	31
PL0600.29.41	92	PL0642.41.63	29	PL0706.00.02	79	PL0748.41.21	43	PL0886.33.67	08	PL0912.31.29	60
PL0600.29.42	92	PL0642.41.66	29	PL0706.41.02	79	PL0750.24.61	64	PL0886.34.67	08	PL0912.33.69	60
PL0600.29.43	92	PL0646.19.41	26	PL0708.21.22	75	PL0752.15.22	79	PL0890.00.22	69	PL0912.34.69	60
PL0602.71.09	91	PL0646.19.42	26	PL0708.22.22	75	PL0752.15.62	79	PL0890.00.01	68	PL0912.41.29	60
PL0604.70.09	91	PL0646.19.43	26	PL0710.00.22	79	PL0752.35.22	79	PL0896.00.02	68	PL0912.42.29	60
PL0606.15.41	28	PL0650.00.01	96	PL0714.21.62	76	PL0752.35.62	79	PL0896.00.21	68	PL0913.00.29	60
PL0606.15.42	28	PL0650.00.03	96	PL0714.22.62	76	PL0752.36.22	79	PL0896.00.22	68	PL0916.13.09	60
PL0606.15.43	28	PL0650.21.01	96	PL0715.00.17	59	PL0752.36.62	79	PL0896.24.61	68	PL0916.14.09	60
PL0606.19.01	28	PL0650.21.03	96	PL0716.01.09	59	PL0753.00.22	79	PL0896.24.62	68	PL0916.41.09	60
PL0606.19.02	28	PL0650.52.01	96	PL0716.02.09	59	PL0754.41.21	43	PL0896.41.01	68	PL0916.42.09	60
PL0606.19.03	28	PL0650.52.03	96	PL0716.21.09	59	PL0755.00.21	43	PL0896.41.02	68	PL0917.01.09	60
PL0606.19.17	28	PL0650.53.01	96	PL0716.21.49	58	PL0756.23.01	22	PL0896.41.21	68	PL0917.02.09	60
PL0606.19.41	28	PL0650.53.03	96	PL0716.22.09	59	PL0756.23.02	22	PL0898.11.61	70	PL0986.01.02	67
PL0606.19.42	28	PL0650.54.01	96	PL0716.22.49	58	PL0756.23.03	22	PL0898.11.62	70	PL0986.41.02	67
PL0606.19.43	28	PL0650.54.03	96	PL0716.23.09	59	PL0756.23.04	22	PL0902.00.21	30	PL0994.01.23	19
PL0606.21.01	28	PL0650.70.01	96	PL0716.23.49	58	PL0758.00.07	22	PL0902.00.22	30	PL0994.02.23	19
PL0606.21.02	28	PL0650.70.03	96	PL0716.24.09	59	PL0758.00.08	22	PL0902.00.23	30	PL0996.12.61	69
PL0606.22.01	28	PL0650.71.01	96	PL0716.24.49	58	PL0760.00.61	22	PL0902.00.32	30	PL0996.24.61	69
PL0606.22.02	28	PL0650.71.03	96	PL0716.31.09	59	PL0760.00.62	22	PL0902.00.61	30	PL1000.01.29	90
PL0606.30.41	28	PL0650.72.01	96	PL0716.32.09	59	PL0760.00.63	22	PL0902.00.62	30	PL1000.02.29	90
PL0606.30.42	28	PL0650.72.03	96	PL0716.41.29	59	PL0762.00.61	22	PL0902.00.63	30	PL1002.01.27	90
PL0606.30.43	28	PL0650.84.16	96	PL0716.41.49	58	PL0762.00.62	22	PL0902.00.72	30	PL1002.02.27	90
PL0606.41.01	28	PL0668.41.41	26	PL0716.42.29	59	PL0762.00.63	22	PL0902.21.21	30	PL1004.01.27	90
PL0606.41.02	28	PL0668.41.42	26	PL0716.42.49	58	PL0780.24.63	21	PL0902.21.22	30	PL1004.02.27	90
PL0606.41.03	28	PL0668.41.43	26	PL0716.47.09	59	PL0782.00.61	21	PL0902.21.23	30	PL1006.01.29	88
PL0606.41.41	28	PL0678.41.61	25	PL0716.47.49	58	PL0782.00.62	21	PL0902.21.32	30	PL1006.02.29	88
PL0606.41.42	28	PL0678.41.62	25	PL0716.48.09	59	PL0782.00.63	21	PL0902.46.21	30	PL1008.01.27	88
PL0606.41.43	28	PL0678.41.63	25	PL0716.48.49	58	PL0786.01.05	57	PL0902.46.22	30	PL1008.02.27	88
PL0607.00.01	28	PL0678.41.72	25	PL0717.00.09	59	PL0786.01.09	57	PL0902.46.23	30	PL1010.01.27	87
PL0607.00.02	28	PL0680.01.01	87	PL0717.00.29	59	PL0786.02.05	57	PL0902.46.32	30	PL1010.02.27	87
PL0607.00.03	28	PL0680.01.02	87	PL0717.23.09	58	PL0786.02.09	57	PL0902.46.61	30	PL1012.01.27	89
PL0608.00.41	28	PL0680.02.01	87	PL0717.33.07	59	PL0787.00.05	57	PL0902.46.62	30	PL1012.02.27	89
PL0608.00.42	28	PL0680.02.02	87	PL0717.33.09	58	PL0787.00.09	57	PL0902.46.63	30	PL1014.01.27	89
PL0608.00.43	28	PL0684.19.61	25	PL0719.00.09	18	PL0788.24.67	21	PL0902.46.72	30	PL1014.02.27	89
PL0608.00.52	28	PL0684.19.62	25	PL0720.13.09	44	PL0790.00.23	19	PL0902.51.21	30	PL1016.01.27	88
PL0608.19.41	28	PL0684.19.63	25	PL0720.14.09	44	PL0796.24.61	21	PL0902.51.22	30	PL1016.02.27	88
PL0608.19.42	28	PL0684.19.72	25	PL0720.41.09	44	PL0796.24.62	21	PL0902.51.23	30	PL1020.01.27	89
PL0608.19.43	28	PL0686.19.41	26	PL0720.42.09	44	PL0796.24.63	21	PL0902.51.32	30	PL1020.02.27	89
PL0608.19.52	28	PL0686.19.42	26	PL0721.00.09	44	PL0798.24.61	21	PL0903.00.21	30	PL1022.01.27	89
PL0610.00.02	86	PL0686.19.43	26	PL0722.01.22	42	PL0798.24.63	21	PL0903.00.22	30	PL1022.02.27	89
PL0610.20.02	86	PL0688.00.41	25	PL0722.02.22	42	PL0800.00.62	21	PL0903.00.23	30	PL1302.00.01	82
PL0612.41.21	53	PL0688.00.42	25	PL0724.01.09	80	PL0802.00.67	91	PL0903.00.32	30	PL1302.00.02	82
PL0612.60.21	53	PL0688.00.43	25	PL0724.02.09	80	PL0804.00.67	91	PL0904.00.21	31	PL1302.00.03	82
PL0614.01.09	64	PL0688.00.52	25	PL0728.13.09	80	PL0806.12.63	20	PL0904.00.22	31	PL1308.00.61	83
PL0614.02.09	64	PL0690.00.41	25	PL0728.14.09	80	PL0806.12.65	20	PL0904.00.23	31	PL1308.13.61	83
PL0614.49.09	64	PL0690.00.42	25	PL0728.21.49	80	PL0806.12.67	20	PL0904.00.32	31	PL1308.51.62	83
PL0614.50.09	64	PL0690.00.43	25	PL0728.22.49	80	PL0806.24.63	20	PL0904.00.61	31	PL1310.00.01	83
PL0615.01.09	64	PL0690.00.52	25	PL0728.41.09	80	PL0806.24.65	20	PL0904.00.62	31	PL1312.00.01	82
PL0615.02.09	64	PL0692.41.21	41	PL0728.42.09	80	PL0806.24.67	20	PL0904.00.63	31	PL1312.00.02	82
PL0616.01.13	27	PL0694.41.61	41	PL0729.00.09	80	PL0808.12.65	20	PL0904.00.72	31	PL1312.00.03	82
PL0616.02.13	27	PL0696.01.01	71	PL0730.01.02	43	PL0808.12.67	20	PL0904.19.21	31	PL1314.00.21	36
PL0616.21.13	27	PL0696.01.02	71	PL0730.02.02	43	PL0808.24.65	20	PL0904.19.22	31	PL1316.00.01	84



Tabela de códigos

CÓDIGO NOVO	PÁG.	CÓDIGO NOVO	PÁG.	CÓDIGO NOVO	PÁG.	CÓDIGO NOVO	PÁG.	CÓDIGO NOVO	PÁG.	CÓDIGO NOVO	PÁG.
PL1316.00.02	84	PL1618.22.51	73	PL2090.62.09	17	PL6018.01.22	74	PL7023.02.22	34	PL9960.00.00	18
PL1316.00.03	84	PL1618.41.11	73	PL2102.61.17	13	PL6018.02.22	74	PL7026.01.22	49	PL9964.19.17	19
PL1318.00.01	82	PL1618.42.11	73	PL2102.62.17	13	PL6019.01.22	74	PL7026.02.22	49	PL9966.19.17	19
PL1318.00.02	82	PL1619.01.11	73	PL2102.77.69	13	PL6019.02.22	74	PL7027.01.22	49	PL9968.19.17	19
PL1318.00.03	82	PL1619.02.11	73	PL2102.78.69	13	PL6020.01.22	75	PL7027.02.22	49	PL9970.19.17	19
PL1322.00.61	32	PL1620.41.27	41	PL2104.61.17	13	PL6020.02.22	75	PL7028.01.22	49	PL9980.12.61	23
PL1322.00.62	32	PL1620.42.27	41	PL2104.62.17	13	PL6022.01.22	75	PL7028.02.22	49	PL9980.12.62	23
PL1322.00.63	32	PL1621.01.27	41	PL2104.75.69	13	PL6022.02.22	75	PL7028.91.22	49	PL9980.12.63	23
PL1322.41.61	32	PL1621.02.27	41	PL2104.76.69	13	PL6023.01.22	75	PL7028.92.22	49	PL9980.24.61	23
PL1322.41.62	32	PL1622.41.62	71	PL2220.01.67	05	PL6023.02.22	75	PL7031.01.22	48	PL9980.24.62	23
PL1322.41.63	32	PL1700.01.01	76	PL2220.02.67	05	PL6024.01.02	42	PL0731.02.22	48	PL9980.24.63	23
PL1334.00.52	32	PL1700.02.01	76	PL2220.01.23	05	PL6024.02.02	42	PL9100.00.50	100	PL9983.00.00	98
PL1334.00.61	32	PL1700.03.02	76	PL2220.02.23	05	PL6026.01.02	67	PL9100.10.50	100	PL9984.41.12	98
PL1334.00.62	32	PL1700.04.02	76	PL2300.33.69	10	PL6026.02.02	67	PL9100.20.50	100	PL9984.42.13	98
PL1334.00.63	32	PL1702.13.09	80	PL2300.34.69	10	PL6027.01.22	67	PL9100.30.50	100	PL9985.00.00	98
PL1334.41.52	32	PL1702.14.09	80	PL2300.61.17	10	PL6027.02.22	67	PL9100.40.50	100	PL9986.00.97	98
PL1334.41.61	32	PL1702.41.09	80	PL2300.62.17	10	PL6028.01.02	61	PL9100.50.50	100	PL9987.41.00	98
PL1334.41.62	32	PL1702.42.09	80	PL2302.33.69	10	PL6028.02.02	61	PL9100.60.50	100	PL9988.00.97	98
PL1334.41.63	32	PL1704.01.01	78	PL2302.34.69	10	PL6030.01.22	47	PL9101.00.50	100	PL9990.00.97	98
PL1338.21.61	82	PL1704.01.21	78	PL2302.61.17	10	PL6030.02.22	47	PL9101.10.50	100	PL9991.41.00	98
PL1340.41.01	84	PL1704.02.01	78	PL2302.62.17	10	PL6031.01.16	47	PL9101.20.50	100	PL9994.17.97	98
PL1340.41.02	84	PL1704.02.21	78	PL2304.33.69	11	PL6031.02.16	47	PL9101.30.50	100	PL9995.37.97	98
PL1340.41.03	84	PL1704.41.01	78	PL2304.34.69	11	PL6031.01.22	47	PL9101.40.50	100	PL9996.17.97	98
PL1341.00.01	84	PL1704.42.01	78	PL2304.61.17	11	PL6031.02.22	47	PL9101.50.50	100	PL9997.37.97	98
PL1341.00.02	84	PL1706.01.17	78	PL2304.62.17	11	PL6032.01.22	47	PL9101.60.50	100	PL9998.17.97	98
PL1341.00.03	84	PL1706.02.17	78	PL2306.33.69	11	PL6032.02.22	47	PL9102.00.50	100	PL9999.17.97	98
PL1354.00.01	22	PL1708.00.22	77	PL2306.34.69	11	PL6035.01.22	75	PL9102.02.00	100		
PL1354.00.02	22	PL1708.13.22	77	PL2306.61.17	11	PL6035.02.22	75	PL9103.00.50	100		
PL1354.00.03	22	PL1710.00.22	78	PL2306.62.17	11	PL6036.01.62	47	PL9104.00.50	100		
PL1356.23.01	85	PL1710.41.22	78	PL2400.33.69	09	PL6036.02.62	47	PL9105.00.50	100		
PL1356.23.02	85	PL1800.01.67	05	PL2400.34.69	09	PL6038.01.22	48	PL9106.00.50	100		
PL1356.23.03	85	PL1800.02.67	05	PL2402.33.69	09	PL6038.02.22	48	PL9107.00.50	100		
PL1427.00.21	51	PL1802.01.63	05	PL2402.34.69	09	PL6040.01.22	67	PL9108.00.50	100		
PL1442.01.67	65	PL1802.02.63	05	PL2600.61.69	12	PL6040.02.22	67	PL9109.00.50	100		
PL1442.02.67	65	PL2000.61.09	15	PL2600.62.69	12	PL6041.01.22	67	PL9200.00.00	100		
PL1443.00.00	65	PL2000.61.17	15	PL2600.79.69	12	PL6041.02.22	67	PL9201.00.00	100		
PL1443.01.67	65	PL2000.62.09	15	PL2600.80.69	12	PL6042.01.02	61	PL9202.00.00	100		
PL1443.02.67	65	PL2000.62.17	15	PL2602.79.69	12	PL6042.02.02	61	PL9203.00.00	100		
PL1446.01.02	62	PL2000.63.09	15	PL2602.80.69	12	PL6050.24.62	67	PL9204.00.00	100		
PL1446.02.02	62	PL2000.63.17	15	PL2604.61.69	12	PL7000.01.22	66	PL9205.00.00	100		
PL1450.19.17	06	PL2000.64.09	15	PL2604.62.69	12	PL7000.02.22	66	PL9900.17.94	97		
PL1452.01.47	06	PL2000.64.17	15	PL2604.79.69	12	PL7001.01.22	66	PL9901.37.94	97		
PL1452.02.47	06	PL2000.79.17	17	PL2604.80.69	12	PL7001.02.22	66	PL9906.17.00	97		
PL1452.11.47	07	PL2000.80.17	17	PL2700.33.67	08	PL7002.01.22	48	PL9911.17.97	97		
PL1452.12.47	07	PL2004.61.09	15	PL2700.34.67	08	PL7002.02.22	48	PL9913.17.97	97		
PL1452.33.47	07	PL2004.61.17	15	PL2700.65.17	08	PL7003.01.22	48	PL9914.17.96	97		
PL1452.34.47	07	PL2004.62.09	15	PL2700.66.17	08	PL7003.02.22	48	PL9916.17.94	97		
PL1452.61.47	07	PL2004.62.17	15	PL2702.01.67	07	PL7004.01.22	48	PL9917.37.94	97		
PL1452.62.47	07	PL2006.59.09	18	PL2702.02.67	07	PL7004.02.22	48	PL9918.17.96	97		
PL1452.57.47	06	PL2006.60.09	18	PL2702.11.67	07	PL7006.01.22	34	PL9919.37.94	97		
PL1452.58.47	06	PL2008.61.09	15	PL2702.12.67	07	PL7006.02.22	34	PL9920.17.97	97		
PL1452.79.47	07	PL2008.62.09	15	PL2702.33.67	07	PL7007.00.22	34	PL9921.17.97	97		
PL1452.80.47	07	PL2010.60.09	17	PL2702.34.67	07	PL7008.01.22	34	PL9922.17.96	97		
PL1500.01.67	05	PL2038.65.10	16	PL2702.79.17	07	PL7008.02.22	34	PL9924.17.96	97		
PL1500.02.67	05	PL2038.66.10	16	PL2702.80.17	07	PL7009.00.22	34	PL9926.17.94	98		
PL1527.00.21	45	PL2040.61.10	16	PL2702.00.00	07	PL7010.01.22	33	PL9928.17.97	98		
PL1527.00.23	45	PL2040.62.10	16	PL2703.01.43	07	PL7010.02.22	33	PL9929.17.97	98		
PL1527.21.21	45	PL2048.65.09	16	PL2703.02.43	07	PL7011.00.22	33	PL9930.17.97	98		
PL1527.21.23	45	PL2048.66.09	16	PL6004.01.02	74	PL7012.01.22	33	PL9931.37.97	98		
PL1550.01.47	80	PL2050.61.09	16	PL6004.02.02	74	PL7012.02.22	33	PL9932.17.94	98		
PL1550.02.47	80	PL2050.62.09	16	PL6005.01.02	74	PL7013.00.22	33	PL9934.17.95	98		
PL1551.00.07	80	PL2054.63.09	17	PL6005.01.16	74	PL7014.01.22	33	PL9936.17.94	98		
PL1614.01.09	64	PL2054.64.09	17	PL6005.02.02	74	PL7014.02.22	33	PL9946.17.00	98		
PL1614.02.09	64	PL2056.61.09	17	PL6005.02.16	74	PL7016.01.22	33	PL9946.41.00	98		
PL1615.00.09	64	PL2056.62.09	17	PL6006.01.02	47	PL7016.02.22	33	PL9947.39.00	98		
PL1616.01.07	65	PL2058.65.70	14	PL6006.02.02	47	PL7018.01.22	66	PL9948.17.00	98		
PL1616.02.07	65	PL2058.66.70	14	PL6007.01.02	47	PL7018.02.22	66	PL9950.17.00	98		
PL1616.21.47	65	PL2066.77.69	14	PL6007.02.02	47	PL7019.00.19	66	PL9951.37.00	98		
PL1616.22.47	65	PL2066.78.69	14	PL6008.01.22	74	PL7020.01.22	66	PL9952.41.00	98		
PL1616.41.07	65	PL2070.33.69	14	PL6008.02.22	74	PL7020.02.22	66	PL9953.39.00	98		
PL1616.42.07	65	PL2070.34.69	14	PL6010.01.22	74	PL7021.00.17	66	PL9954.17.00	98		
PL1617.01.07	65	PL2076.75.69	14	PL6010.02.22	74	PL7022.01.22	66	PL9955.17.00	98		
PL1617.02.07	65	PL2076.76.69	14	PL6016.01.02	61	PL7022.02.22	66	PL9956.17.97	98		
PL1618.21.51	73	PL2090.61.09	17	PL6016.02.02	61	PL7023.01.22	34	PL9958.17.00	98		

MATERIAIS DE PUNTO DE VENDA

PÔSTER

- Impresso em papel couché
- Aplicação de verniz protetor
- Dimensões: 66cm x 99cm

PAINEL FULL SUPPLY

- Impresso em lona vinílica
- Aplicação de verniz protetor
- Moldura tipo pôster
- Haste para fixação
- Dimensões: 1,70m x 1,00m*



PAINEL BALCÃO

- Painel em MDF e ACM
- Com fonte bivolt
- Lanternas LED **
- Dimensões: 51cm x 49cm x 14,5cm

PAINEL TRIPLO X

- Painel em ACM
- Com fonte bivolt
- Lanternas LED **
- Dimensões: 67cm x 71cm

PAINEL MODULUS

- Painel em ACM
- Com fonte bivolt
- Lanternas LED
- Dimensões: 58cm x 39cm

CONSULTE SEU REPRESENTANTE E SAIBA COMO GARANTIR O SEU.

* O painel pode ser adaptado de acordo com o espaço disponível na loja do cliente.

** Consulte com seu representante os modelos das lanternas aplicáveis neste painel.